

# Hammerfest 70-A XL

Wandaußenmaß: 360 x 300 cm

Bohlenstärke: 70 mm



Durch Kunden farblich endbehandelt

Kontrolliert durch:

Achtung: Alle angegebenen Maße sind ca.-Maße!

# 3D-Darstellung und Grundriss Hammerfest 70-A XL

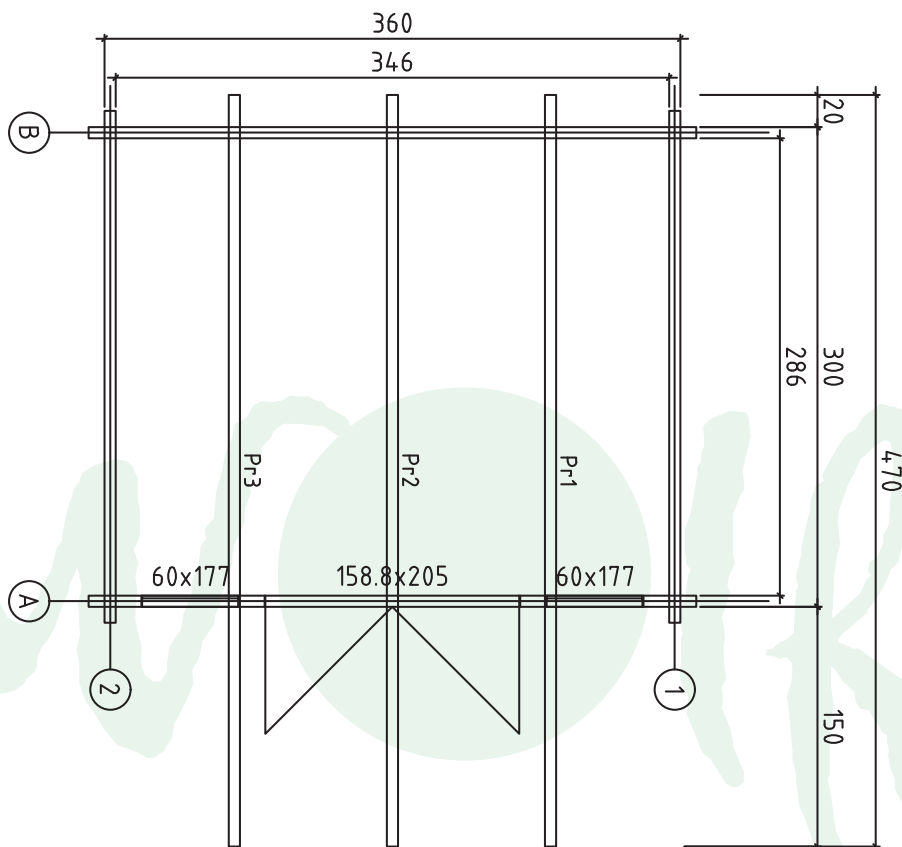
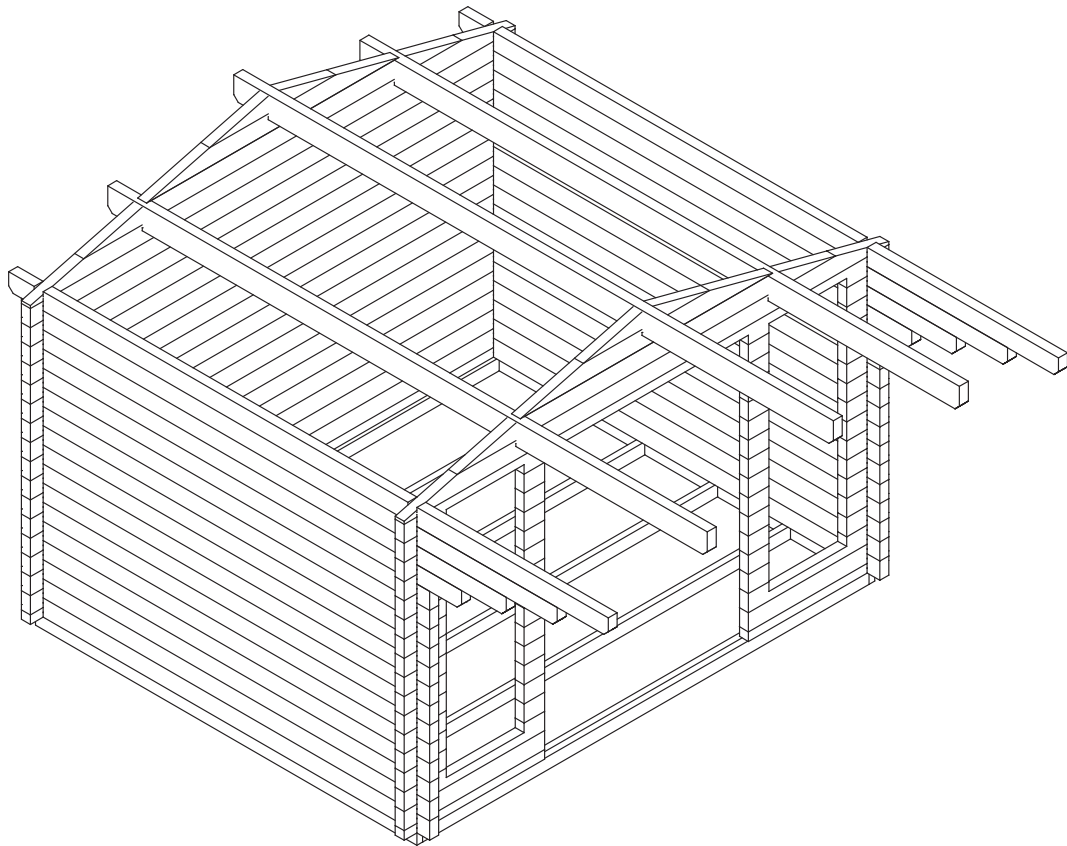





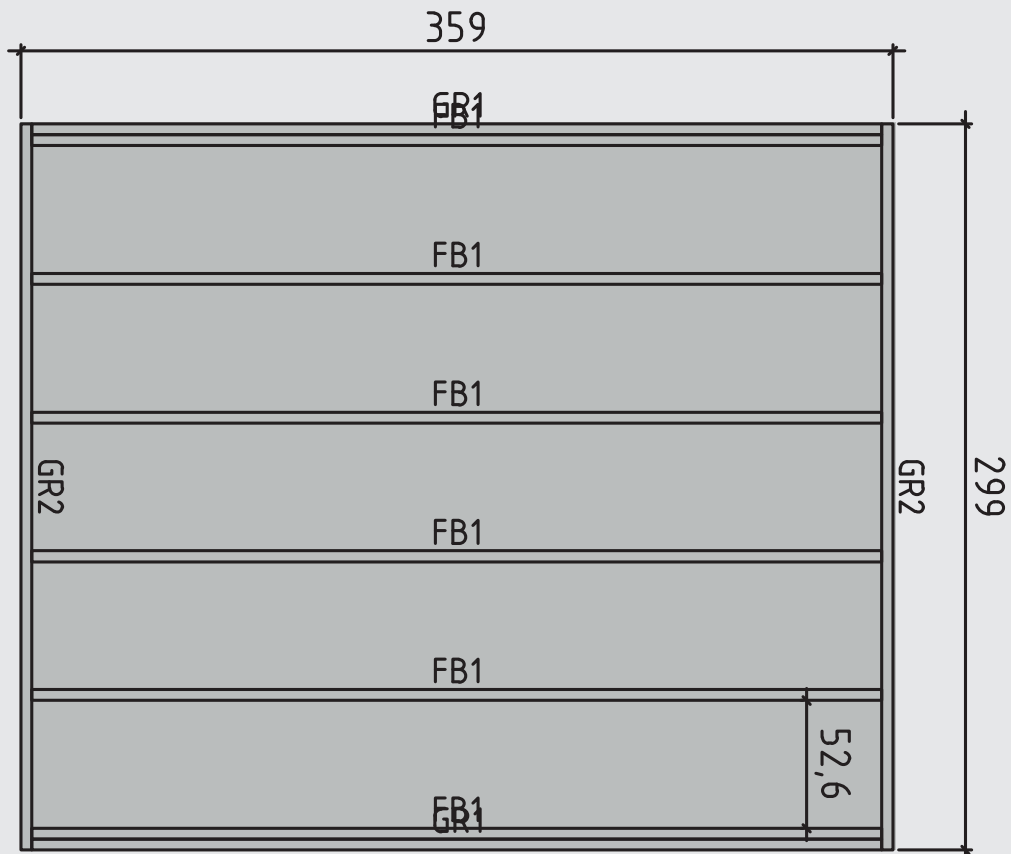





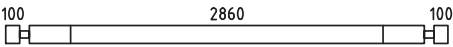
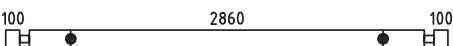
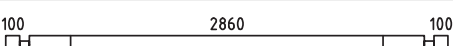
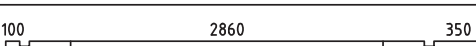
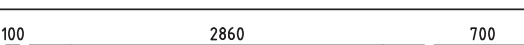
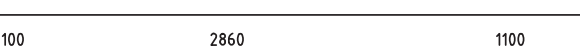

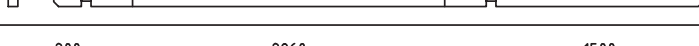
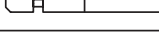
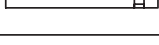
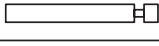

# Lagerholzplan und Fundamentplan Hammerfest 70-A XL

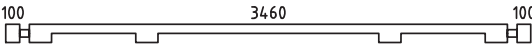
Wir empfehlen als Fundament für Ihr Gartenhaus eine vollflächig,  
festgegründete gepflasterte oder betonierte Fläche.  
Wahlweise ist auch ein Punkt- oder Streifenfundament möglich.

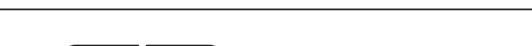
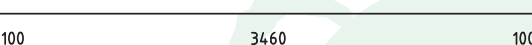

# Teileliste 1

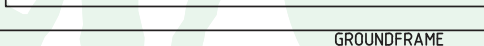
## Hammerfest 70-A XL

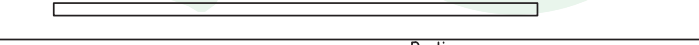
Pos			Profil (mm)	Lenght (mm)
001		2	70x130	3200
002		2	70x130	3200
003		22	70x130	3200
004		2	70x130	3450
005		2	70x130	3800
006		2	70x130	4200
007		1	70x130	4700
008		1	70x130	4700
009		2	70x65	1101
010		2	70x130	1101
011		2	70x130	1101
012		26	70x130	331
013		26	70x130	160
014		1	70x130	3800
015		2	70x130	3800
016		8	70x122	464
017		2	70x130	1917
018		2	70x130	1977
019		1	70x65	3800
020		16	70x130	3800
GR1	GROUNDFRAME 	2	45x90	3500
GR2	GROUNDFRAME 	2	45x90	2990
FB1	FLOORBEAMS 	6	45x90	3500
Pr1	Purlins 	1	70x170	4700
Pr2	Purlins 	1	70x170	4700



# Teileliste 3

## Hammerfest 70-A XL

POS	ST.	B	H	L	Teileliste	
FB1	Vt. spetsi				FUNDMENTHOLZER	
F1	9,89 m <sup>2</sup>	28		2855	FUSSBODENBRETTER	40/31/26
PR	3	70	170	4700	DACHBALKEN	
RB1	19,92 m <sup>2</sup>	20		2120	DACHBRETTER	122/94/78
R1	2	20	120	4700	<i>Vaata katuse kaldenurka</i> Traufenbretter	
R2	2	45	65	4700	<i>Vaata katuse kaldenurka</i> Traufenbretter	
R3	4	20	120	2300	<i>Vaata katuse kaldenurka</i> Giebelabschlussleiste	
R4	4	20	90	2300	Giebelabschlussleiste	
WN06	2	600	1770			
DR16	1	1588	2050			
Sliding slats 30x30x1575 mm - 4 pcs.						
P1	14 m	20	40		Fußbodenleiste	
P2	6+6	20	90	2030	Türleiste DR 16, Fensterleiste WN 06	
P3	1+1	20	90	3440	Türleiste DR 16, Fensterleiste WN 06	
P4	2+2	20	90	<del>540</del> 570	Fensterleiste WN 06	

# Detailzeichnungen Hammerfest 70-A XL

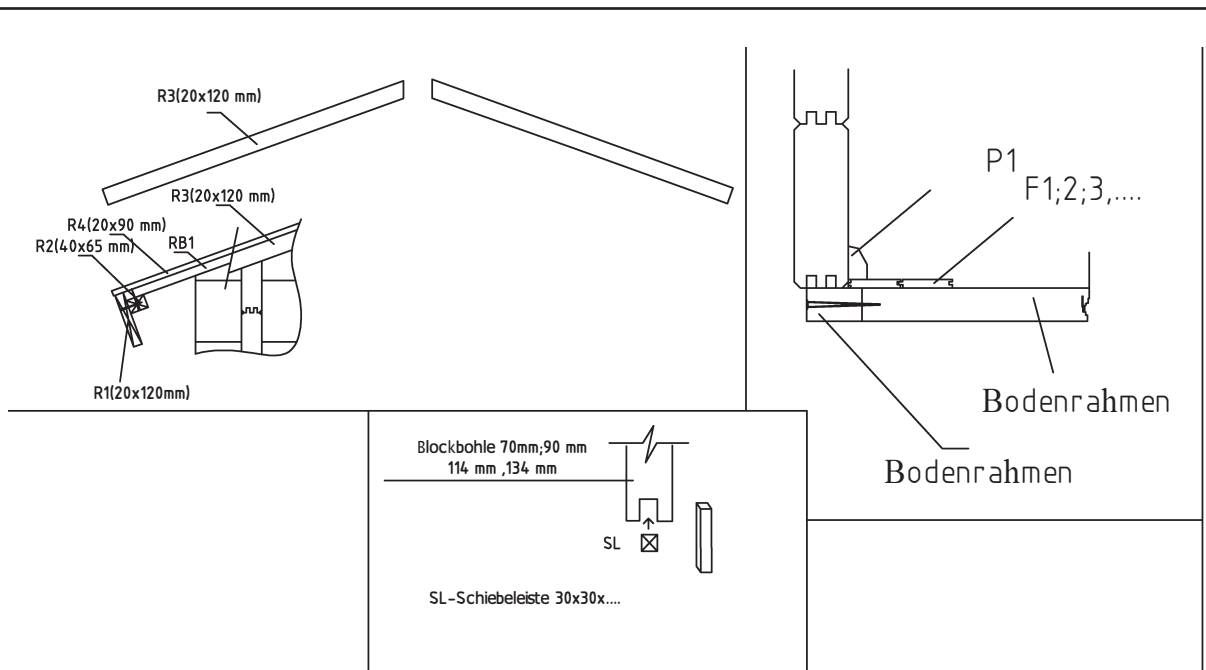

## Dichtungssystem der Blockbohlen

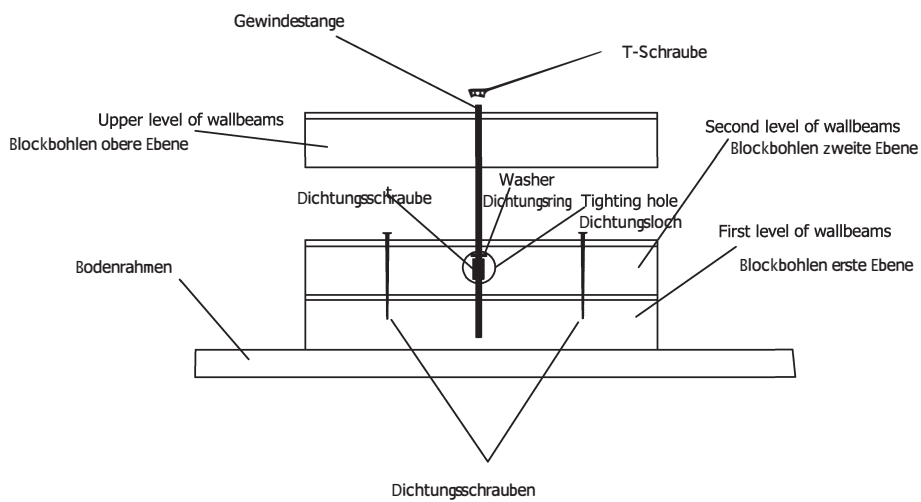

# Wandplan 1 und 2 Hammerfest 70-A XL

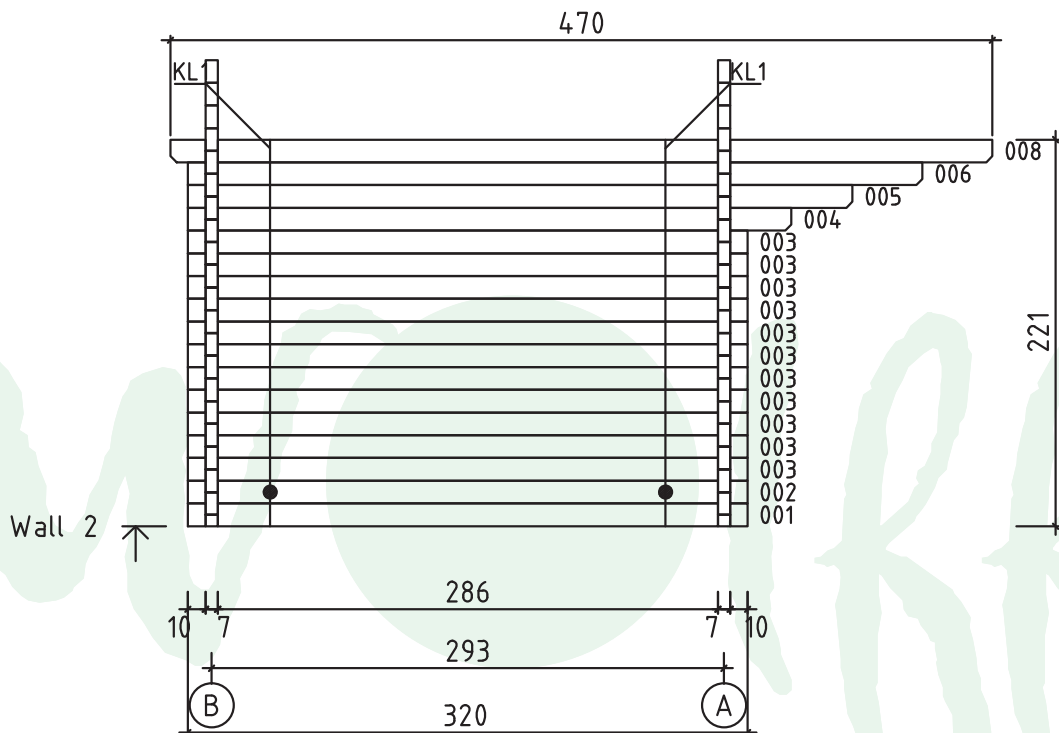
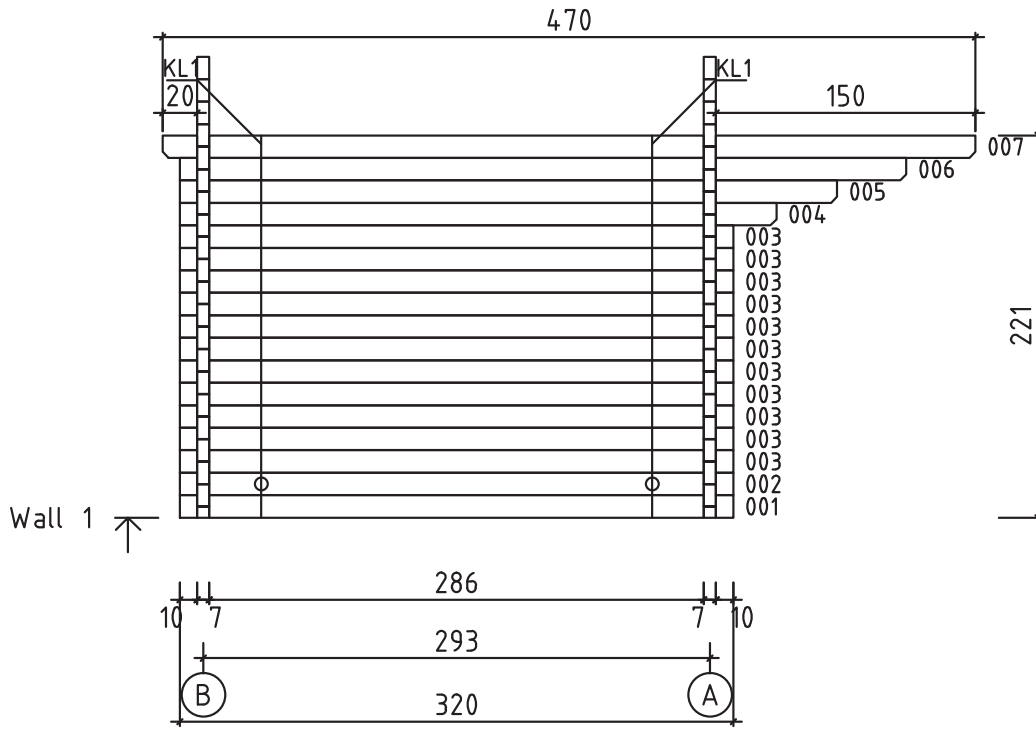



# Wandplan A und B Hammerfest 70-A XL

