

# Technische Daten Oslo 34-G XL Klassik / Modern

Wandaußenmaß: 360 x 360 cm, Bohlenstärke: 34 mm



Kontrolliert durch:

Achtung: Alle angegebenen Maße sind ca.-Maße!

# 3D-Darstellung Oslo 34-G XL Klassik / Modern

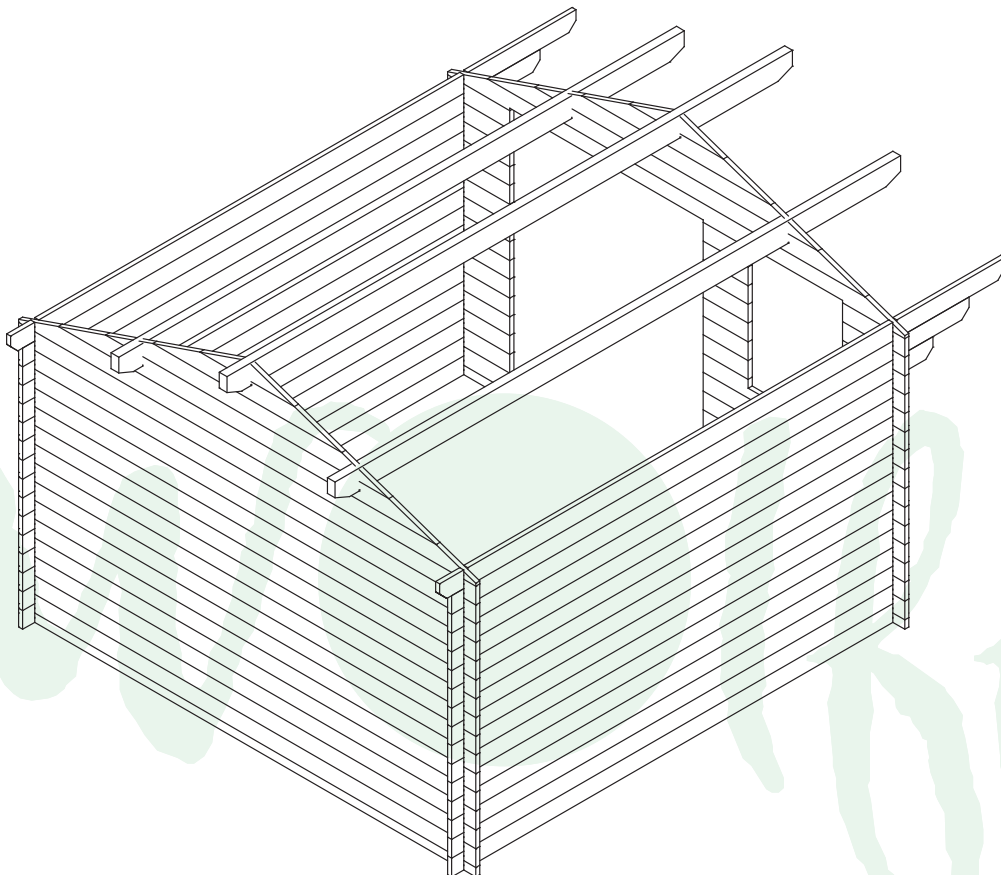
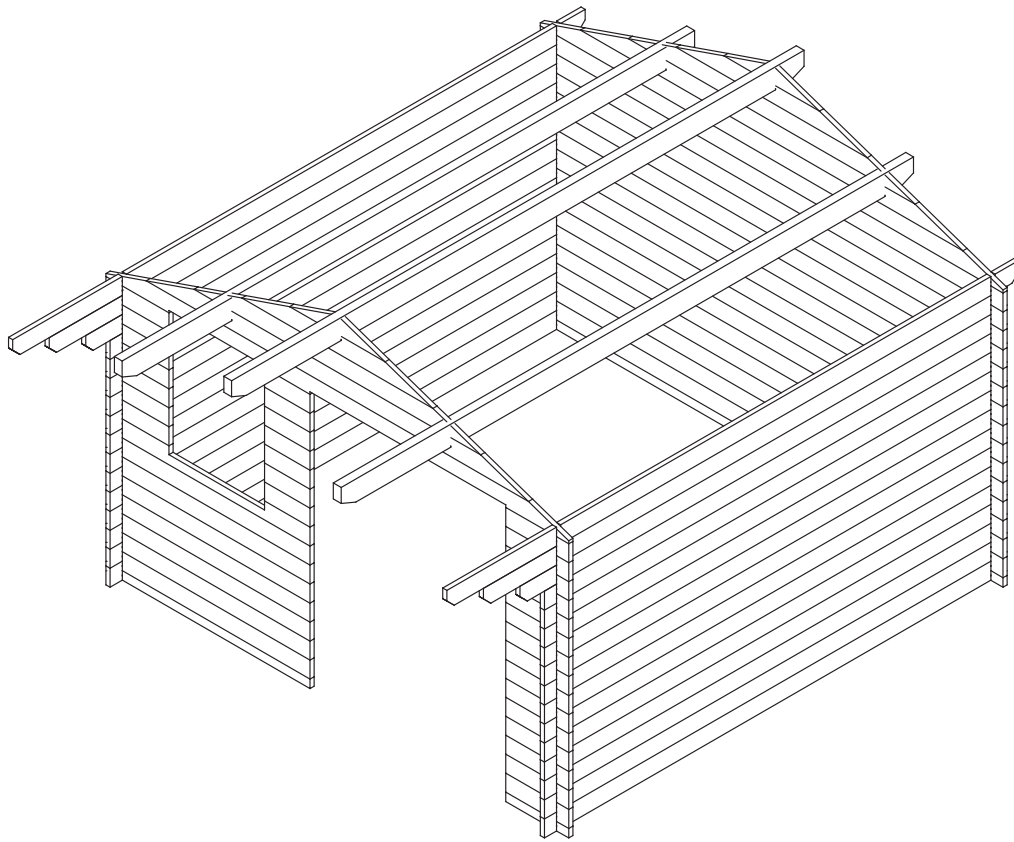

# Grundriss Oslo 34-G XL Klassik / Modern

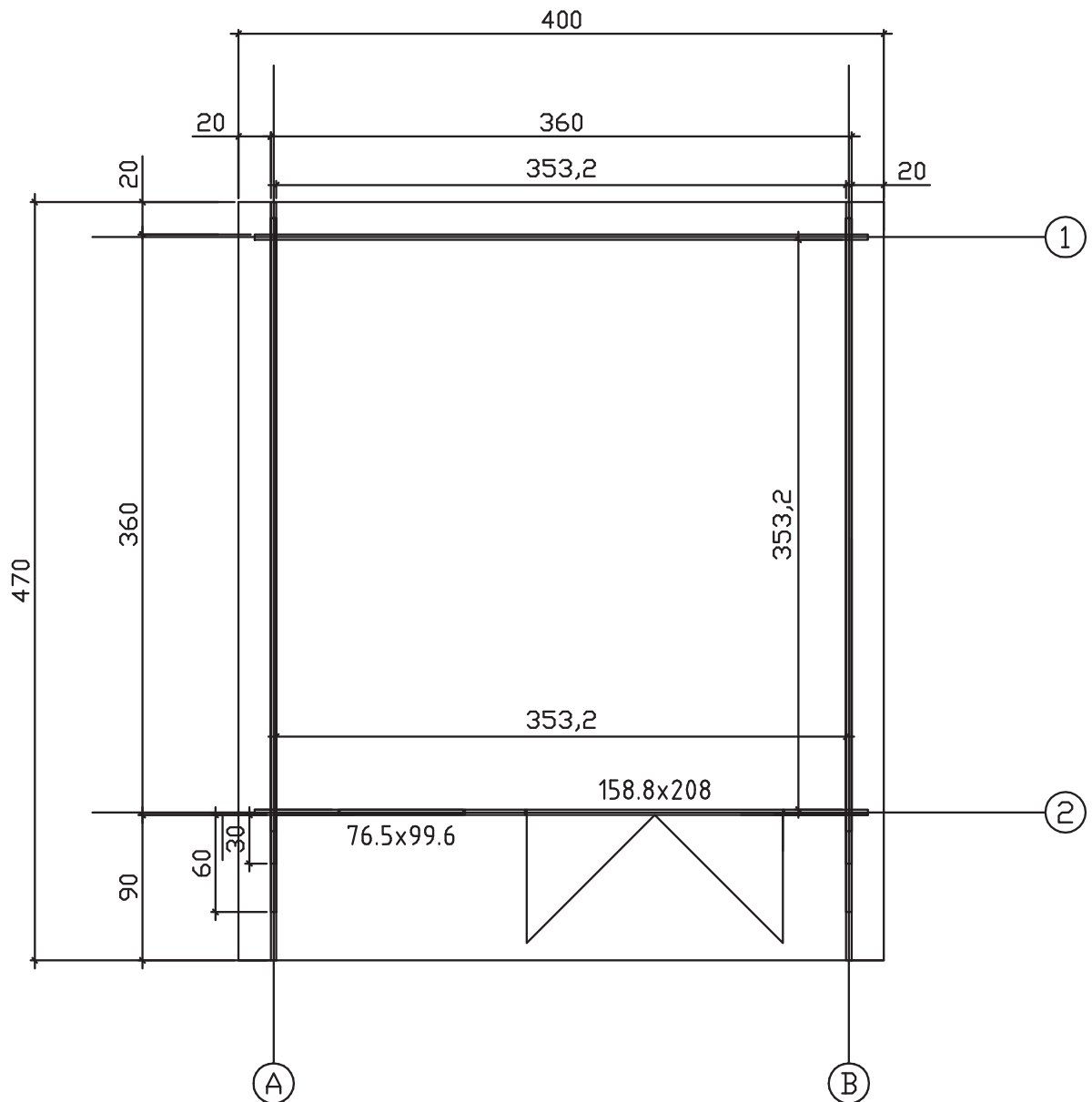





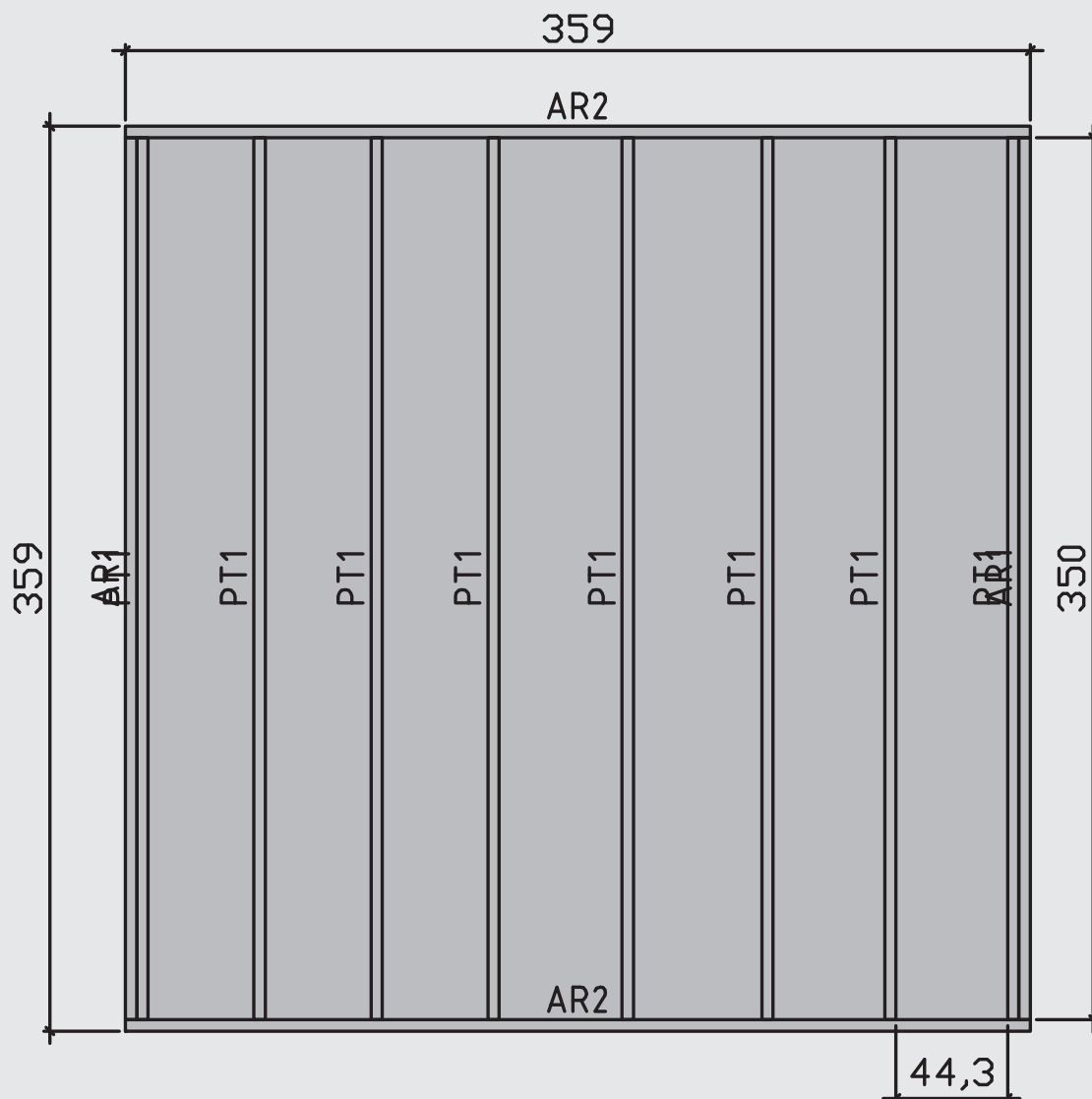





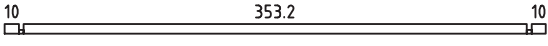
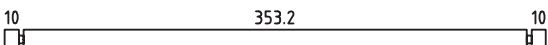
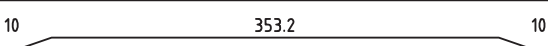
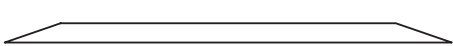
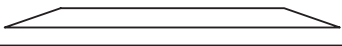
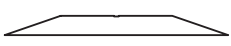

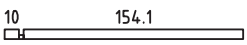

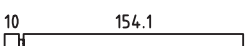
# Fundamentplan Oslo 34-G XL Klassik / Modern

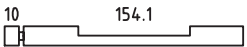
Wir empfehlen als Fundament für Ihr Gartenhaus eine vollflächig, festgegründete gepflasterte oder betonierte Fläche.  
Wahlweise ist auch ein Punkt- oder Streifenfundament möglich.

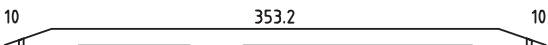
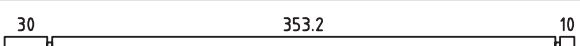
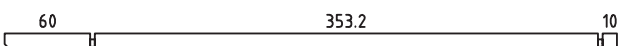





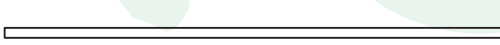





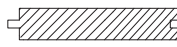

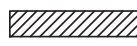

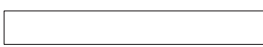
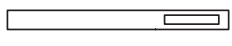
# Teileliste 1

## Oslo 34-G XL Klassik / Modern

Pos		Pcs	Profile (cm)	Length (cm)
001		1	3.4x6.8	380
002		41	3.4x13.5	380
003		1	3.4x13.5	380
004		2	3.4x13.5	314
005		2	3.4x13.5	235.5
006		2	3.4x13.5	157
007		4	3.4x12.9	37.6
008		1	3.4x6.8	167.5
009		1	3.4x6.8	51.7
010		7	3.4x13.5	167.5
011		22	3.4x13.5	51.7
012		1	3.4x13.5	167.5
013		7	3.4x13.5	37.3
014		1	3.4x13.5	380
015		2	3.4x13.5	400
016		2	3.4x13.5	430
017		1	3.4x13.5	470
018		1	3.4x13.5	470
AR2		2	4.5x7	359
AR1		2	4.5x7	350
PR1		2	4.3x14.5	470
PR2		1	4.3x14.5	470
PT1		8	4.5x7	350
	WINDOW 76.5x99.6	1		
	DOOR 158.8x208	1		

# Teileliste 2

## Oslo 34-G XL Klassik / Modern

Pos			Pcs	Profile (cm)	Length (cm)
019	FLOOR BOARDS/FUSSBODEN/LAME DE PLANCHER		32	11.2x1.8	352.4
020	ROOF BOARDS/DACHBRETTER/VOLIGE		84 69	11.2x1.8 13.7x1.8	211.5 211.5
021	ROOF EDGE REINFORCEMENT/TRAUFENLEISTE/TASSEAU		2	2.6x3.2	470.0
022	ROOF SIDE BOARDS/TRAUFENBRETT/PLANCHE DE RIVE		2	1.8x9	470.0
023	FASCIA BOARD/GIEBELBLENDE/PLANCHE DE RIVE (FACADE)		4	1.8x12.0	217.2
024	FASCIA BOARD/GIEBELBLENDE/PLANCHE DE RIVE (FACADE)		4	1.8x6.0	217.2
025	PULLER/STURMLEISTEN/GARNITURE SLAT		4	2.6x3.2	200.0
026	STORM EDGE/STURMLEISTEN/STORM MOLDING		4	2.6x3.2	200.0
027	FLOOR EDGE TRIM/FUßLEISTEN/PLINTHE PLANCHER		4	2.0x4.5	353.0
028	DIAMOND/RAUTE/DIAMANT		2	1.8x12	120
029	METAL BOLT/BOLT/BOLT		8	M8	80
030	Shim, Nut/Mutter, U-Scheibe/ECROU, Rondelle - M10 mm - For fixing storm braces/Pour fixer les anti-tempete/Für Sturmleisten		8	M8	
031	Nails/Nägels/Clous 2.5 x 50 mm - For fixing roofboards Befestigung Dachbretter/Pour fixer les voliges		720		
032	Nails/Nägels/Clous 2.0 40 mm - For fixing roofing felt fillet (18 x 90 mm)/ Befestigung Giebelabschlussbrett (18 x 90 mm)/ Pour fixer la latte de finition de la couverture (18 x 90 mm)		20		
033	Screws/Schrauben/Vis 4 x 50 mm - For fixing roof side boards and roof edge reinforcement/Befestigung Traufenbretter und Traufenleisten Pour fixer les planches de rive et le tasseau (30 x 34 mm) de renfort		105		
034	Nails/Nägels/Clous 2.5 x 25 mm - For fixing floorboards/ Befestigung Fußbodenbretter/Pour fixer les lames de plancher		52		
035	Nails/Nägels/Clous 1.4 x 40 mm - For fixing floor edge trims (19 x 19 mm)/ Befestigung Fußleisten/Pour fixer les plinthes du plancher (19 x 19 mm)		32		



# Wandplan 1 und 2 Oslo 34-G XL Klassik / Modern

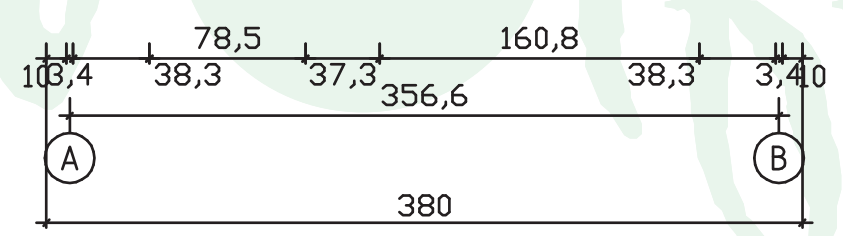
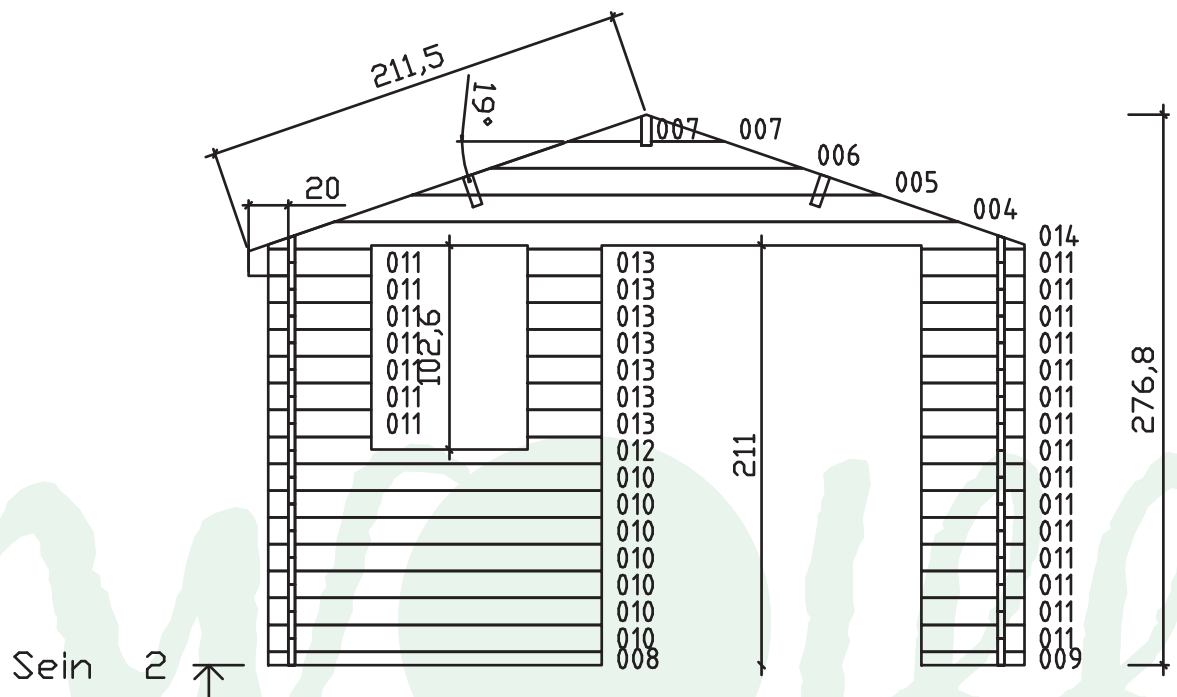
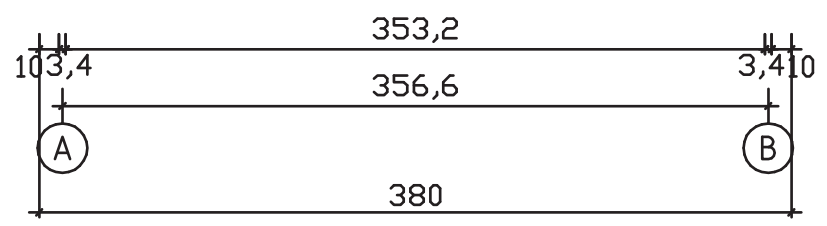
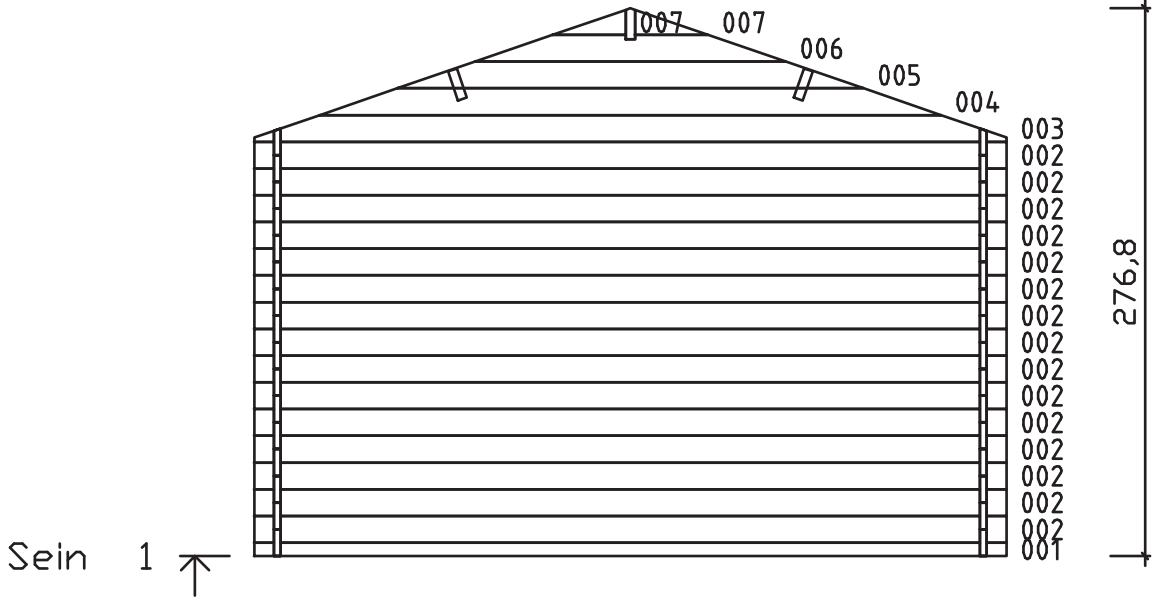

# Wandplan A und B

## Oslo 34-G XL Klassik / Modern

