

# Technische Daten Lyon C

Wandaußenmaß: 292 x 230 cm

Bohlenstärke: 28 mm



Kontrolliert durch:

Achtung: Alle angegebenen Maße sind ca.-Maße!

# 3D-Ansicht Lyon C





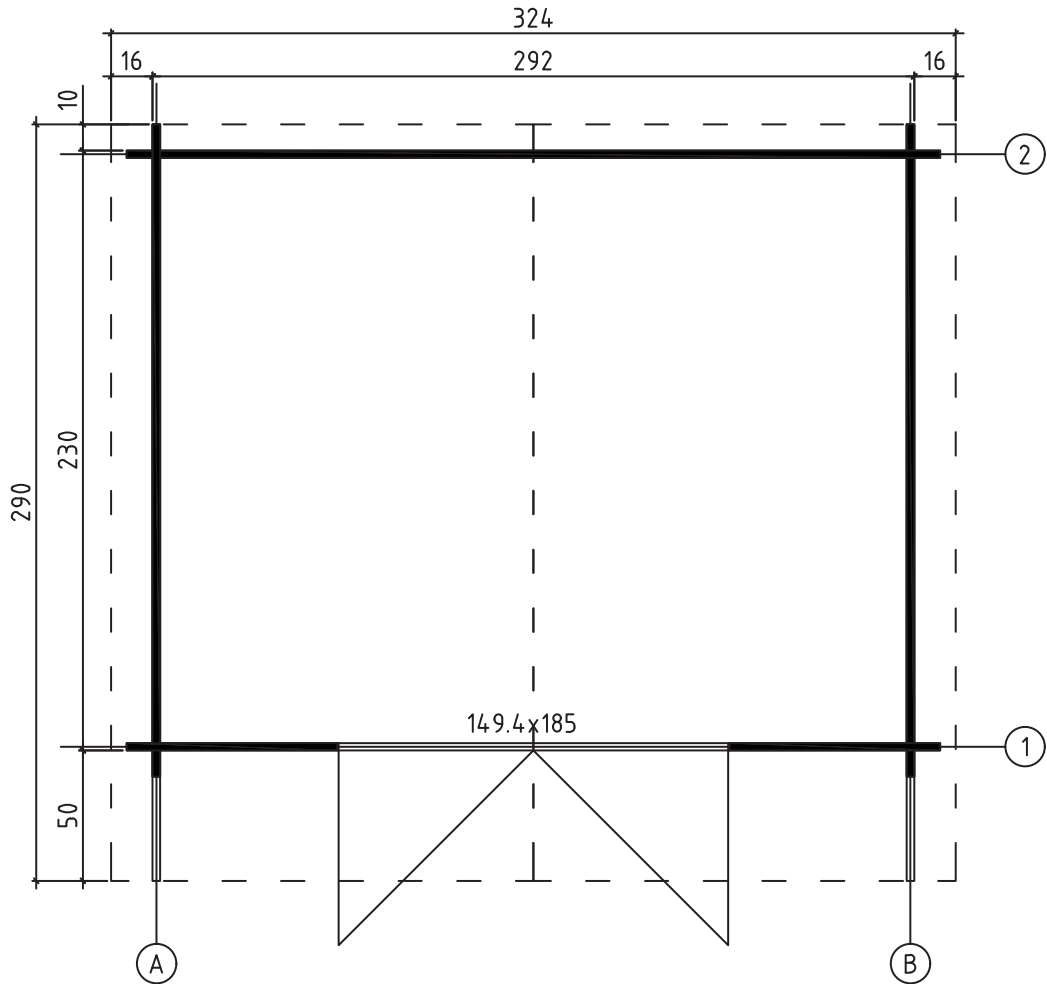





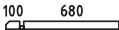
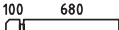
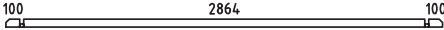
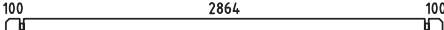
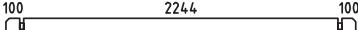
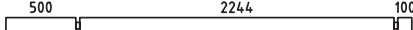
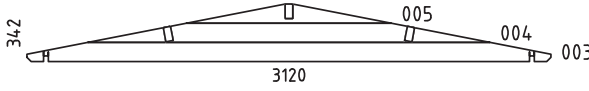
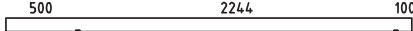



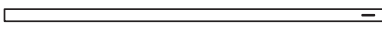

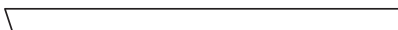

# Grundriss Lyon C

















# Teileliste 1

## Lyon C

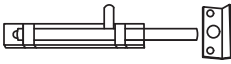
Pos			P (mm)	L (mm)
001			2	28x57 808
002			32	28x114 808
006			1	28x57 3120
007			16	28x114 3120
008			32	28x114 2500
009			2	28x114 2900
W1-1 W2-1			1 1	
A-PR1	 ROOF BEAM - DACHBALKEN - PANNE DE TOIT		3	44x95 2900
DB	ROOF BOARDS - DACHBRETTNER - VOLIGES 		66	90x15 1650
	ROOFING FELT FILLET - DACHPAPPENLEISTE - BAGUETTE DE FIXATION DU FEUTRE BITUMEUX 		4	15x45 1700
DRV	ROOF EDGE REINFORCEMENT - DACHRANDVERSTÄRKUNG - CORNIERE DE RENFORT DE BORD DE TOIT 		2	15x45 2900
KFS	STORM PROTECTION - STURMLEISTE - - LATTE ANTI-TEMPETE 		4	22x45 2050
	ROOFING FELT (STRIP) - DACHPAPPE (BAHNEN) - - FEUTRE BITUMEUX (BANDE) 		4	3000
	GABLE MOULDING - GIEBELLEISTE - - PLANCHE DE RIVE 		4	15x120 1700
	SCREW FOR GEORGIAN BARS - SCHRAUBE FÜR SPROSSEN - VIS POUR CROISSILLONS DE PORTE 		8	2.5x20
HS12	SCREW FOR GABLE SEGMENT - SCHRAUBEN FÜR DECKBLATT - VIS POUR FIXATION LOSANGE DE FINITION 		4	3.5x35
HS22	SCREW FOR FIXING DOOR TO THE WALL - SCHRAUBE ZUR BEFESTIGUNG TÜR - ZARGE MIT WAND - VIS POUR FIXATION DORMANT DE PORTE AU 1ER RANG DE MADRIER 		2	3.5x50
HS16	SCREW FOR GABLE MOULDING - SCHRAUBEN FÜR GIEBELLEISTE - VIS POUR FIXATION PLANCHE DE RIVE 		24	3.5x50
HS59	SCREW FOR DOORSTEP - SCHRAUBEN FÜR SWELLE - VIS POUR FIXATION BARRE DE SEUIL 		3	3x30
	SCREW FOR ROOF EDGE REINFORCEMENT - SCHRAUBEN FÜR DACHRANDVERSTÄRKUNG - VIS POUR RENFORT DE BORD DE TOIT 		14	3x30
HS3	SCREW FOR DOOR FILLET - SCHRAUBE ZUR BEFESTIGUNG TÜRLAISTE - VIS POUR FIXATION BAGUETTE D'ARRET DE PORTE 		5	3x30
HS56	SCREW FOR FIXING BOLT HINGE - SCHRAUBE FÜR TÜRRIGEL - VIS POUR FIXATION GONDS DE PORTE - POUR OUVRANT 		16	4x30
HS58	SCREW FOR FIXING BOLT HINGE - SCHRAUBE FÜR TÜRRIGEL - VIS POUR FIXATION GONDS DE PORTE - POUR OUVRANT 		12	4x40
HS41	SCREW FOR DOOR JAMB - SCHRAUBE FÜR TÜRRAHMEN - VIS POUR FIXATION MONTANT DE PORTE 		2	4x60

# Teileliste 2

## Lyon C

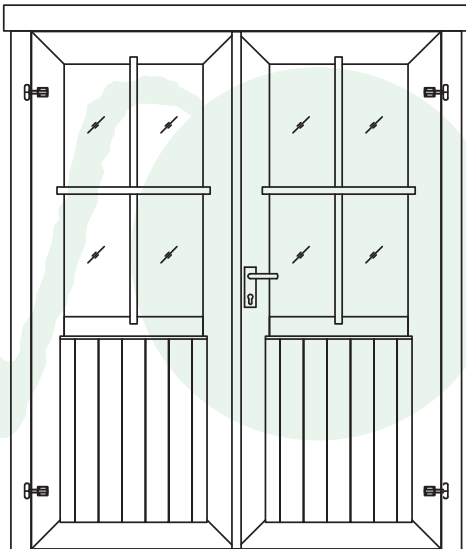
Pos				P (mm)	L (mm)
HS43	SCREW FOR ROOF BEAMS - SCHRAUBEN FÜR DACHBALKEN - VIS POUR FIXATION PANNES DE TOIT		10	5x120	
HS41	SCREW FOR DOOR JAMB - SCHRAUBE FÜR TÜRRAHMEN - VIS POUR FIXATION MONTANT DE PORTE		2	5x90	
SH28	HAMMER BLOCK - SCHLAGHOLZ - CALLE DE FRAPPE		1		
SFS	NUT FOR STORM PROTECTION - SCHRAUBENMUTTER FÜR STURMLEISTE - ECROU POUR LATTE ANTI-TEMPETE		8	D6	
NF2	ZN NAIL FOR ROOF - ZN NÄGEL FÜR DACHBRETTER - POINTE POUR FIXATION VOLIGES DE TOIT		212	2x50	
NFD	ZN NAIL FOR ROOFING FELT FILLET - ZN NÄGEL FÜR DACHPAPPENLEISTE - POINTE POUR BAGUETTE DE FIXATION FEUTRE BITUMEUX		16	2x40	
NF	ROOFING NAILS FOR ROOFING FELT - NÄGEL FÜR DACHPAPPE - POINTE POUR FIXATION FEUTRE BITUMEUX		105	2.8x15	
	MALE BOLT HINGE FOR DOOR - TÜRRIEGEL - PARTIE MALE DE PAUMELLE DE PORTE		4		
BFS	BOLT FOR STORM PROTECTION - BOLZEN FÜR STURMLEISTE - BOULON POUR LATTE ANTI-TEMPETE		8	6x60	
TL	LATCH BOLT FOR DOUBLE DOOR - TORRIEGEL - LOQUET POUR DOUBLE PORTE		2		90
GS	GABLE SEGMENT - DECKBLATT - LOSANGE DE FINITION		2		
DFS	WASHER FOR STORM PROTECTION - DICHTSCHEIBE FÜR STURMLEISTE - RONDELLE POUR LATTE ANTI-TEMPETE		8	D6	
TL4	DOOR HANDLE FITTINGS - TÜRRGRIFF - POIGNEE DE PORTE		1		
TL5	SET OF DOOR LOCK COVERS - SCHLOSSBLENDEN - SET DE GARNITURES DE PORTE		1		
	CYLINDER LOCK - ZYLINDERSCHLOSS - BARILLET DE PORTE		1	30/30	
	DOOR - TÜR - PORTE 1494x1850 SGA+28	TUK.2.044.SVP.MX28	1		
					





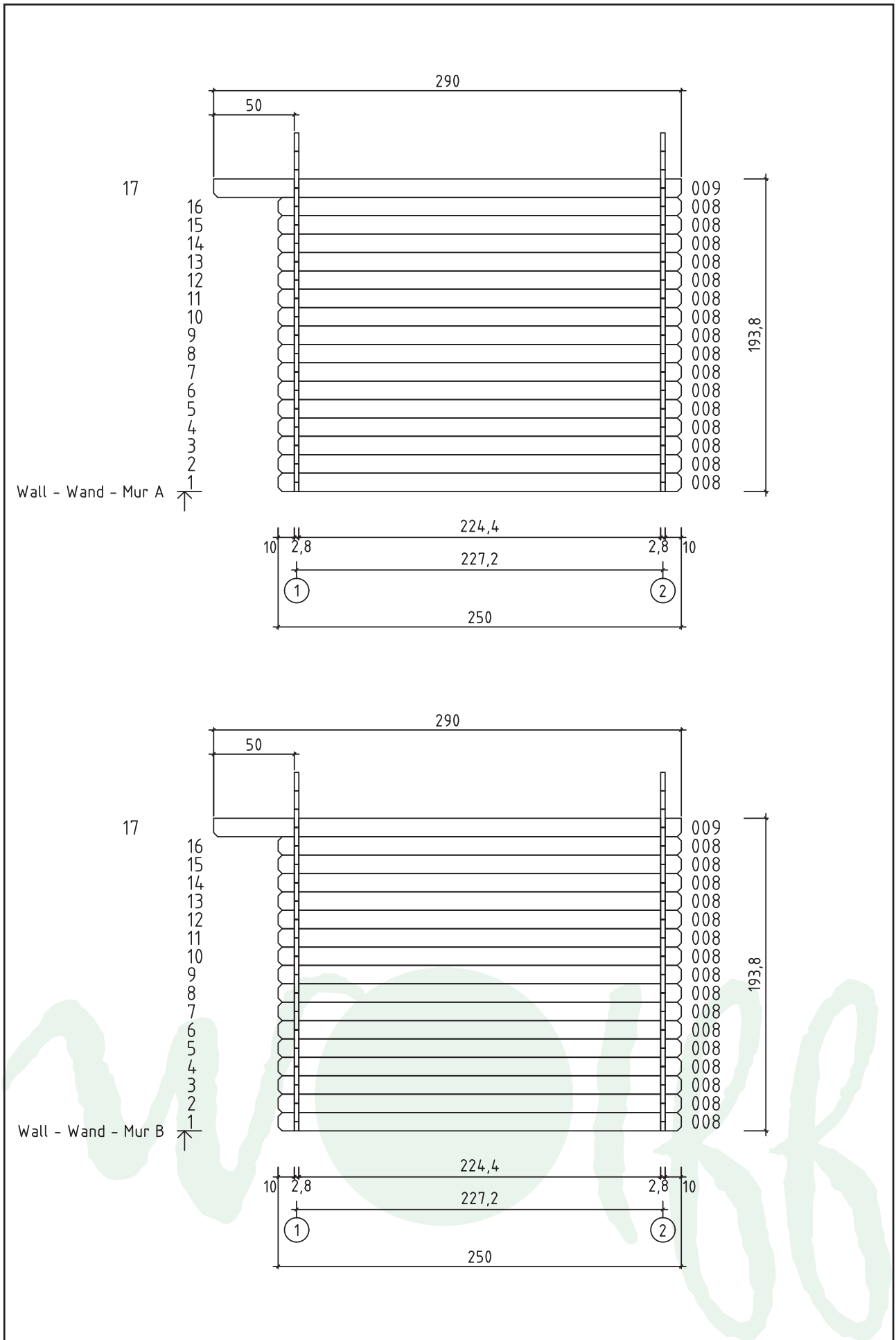

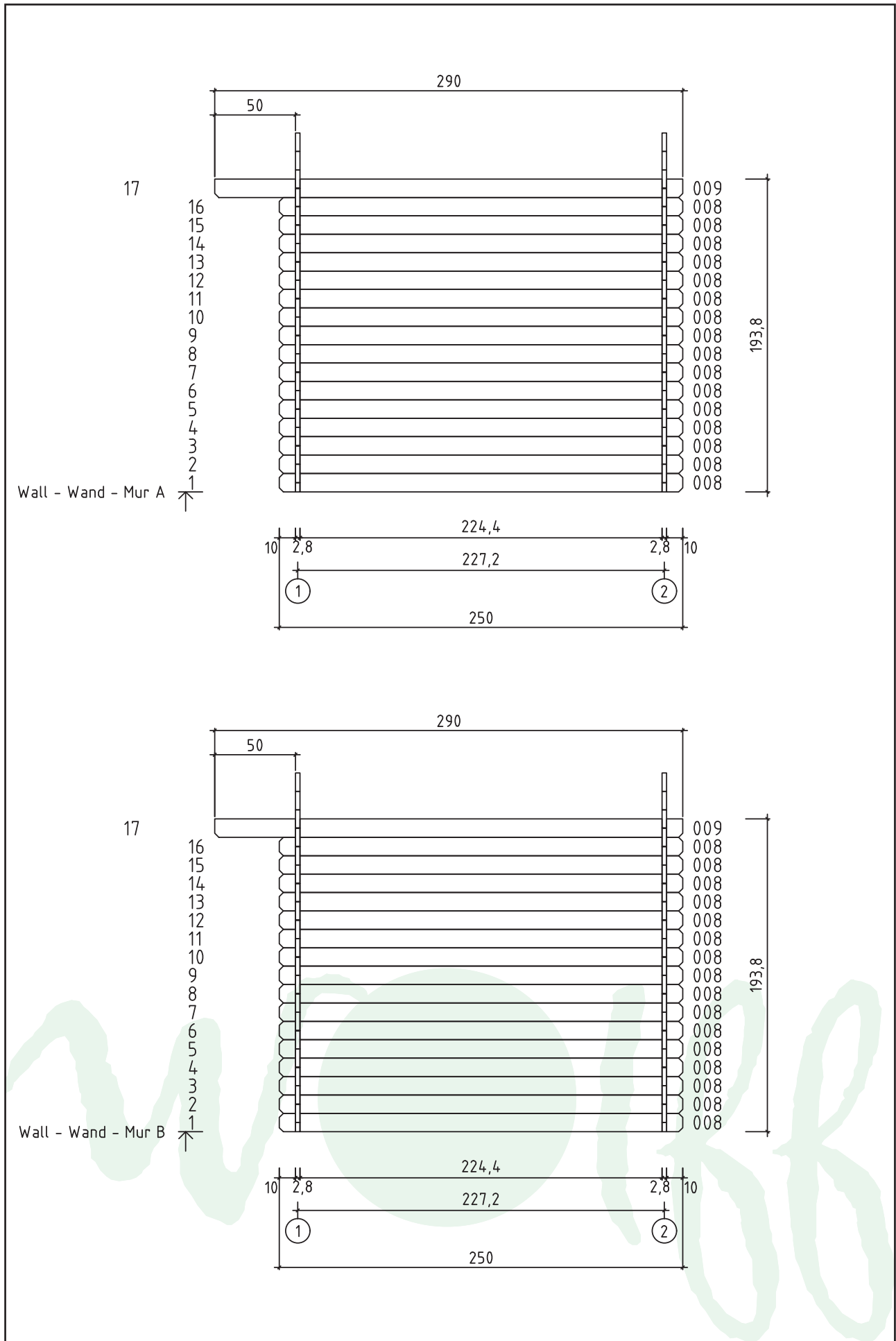

# Wandplan 1 und 2 Lyon C

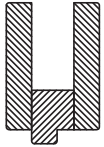
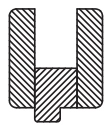

# Wandplan A und B Lyon C

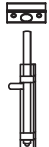

# Detail 1 Lyon C

Pos		P (mm)
1		66x100
2		66x80
3		18x18
4		13x32
5		15x25
6		2
7		4

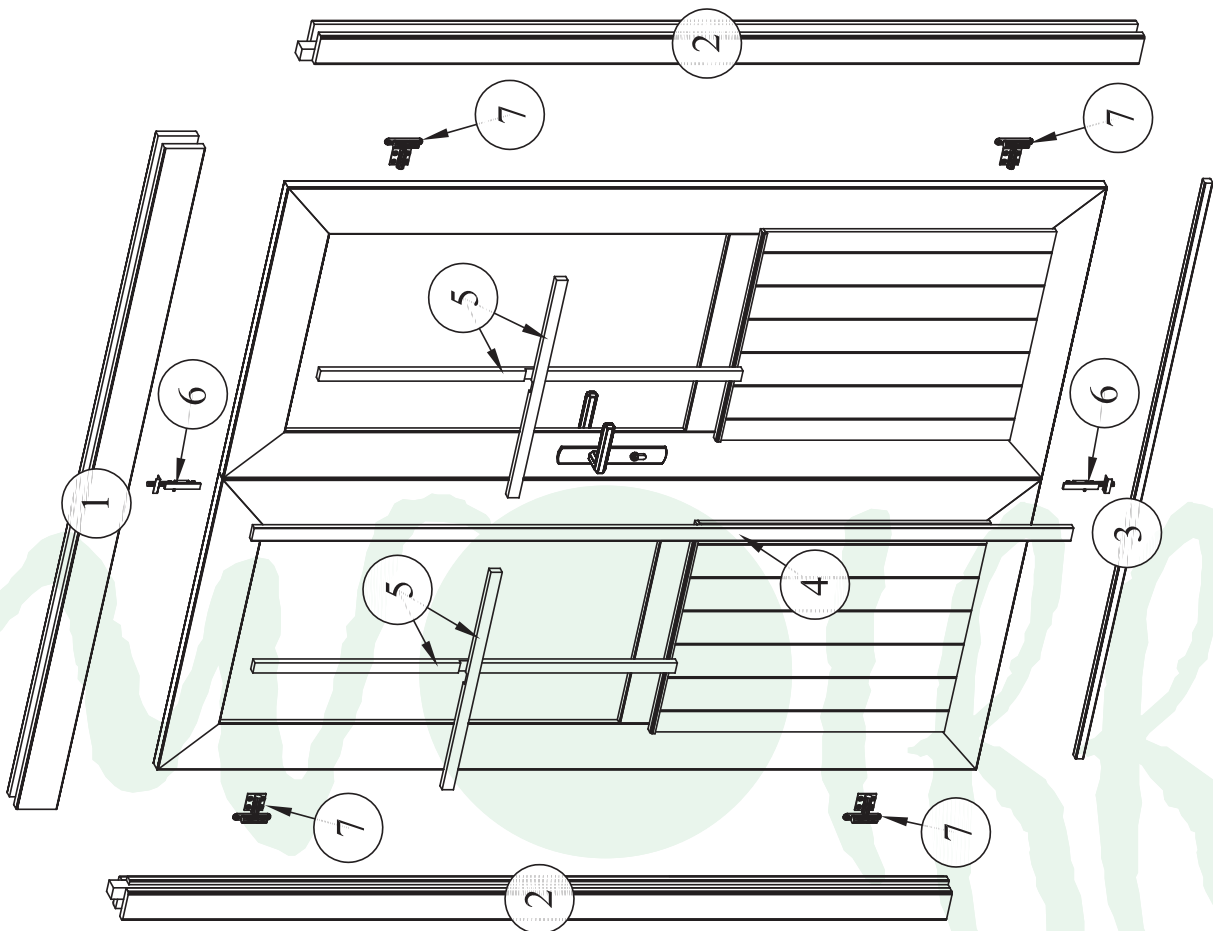



# Detail 2 Lyon C

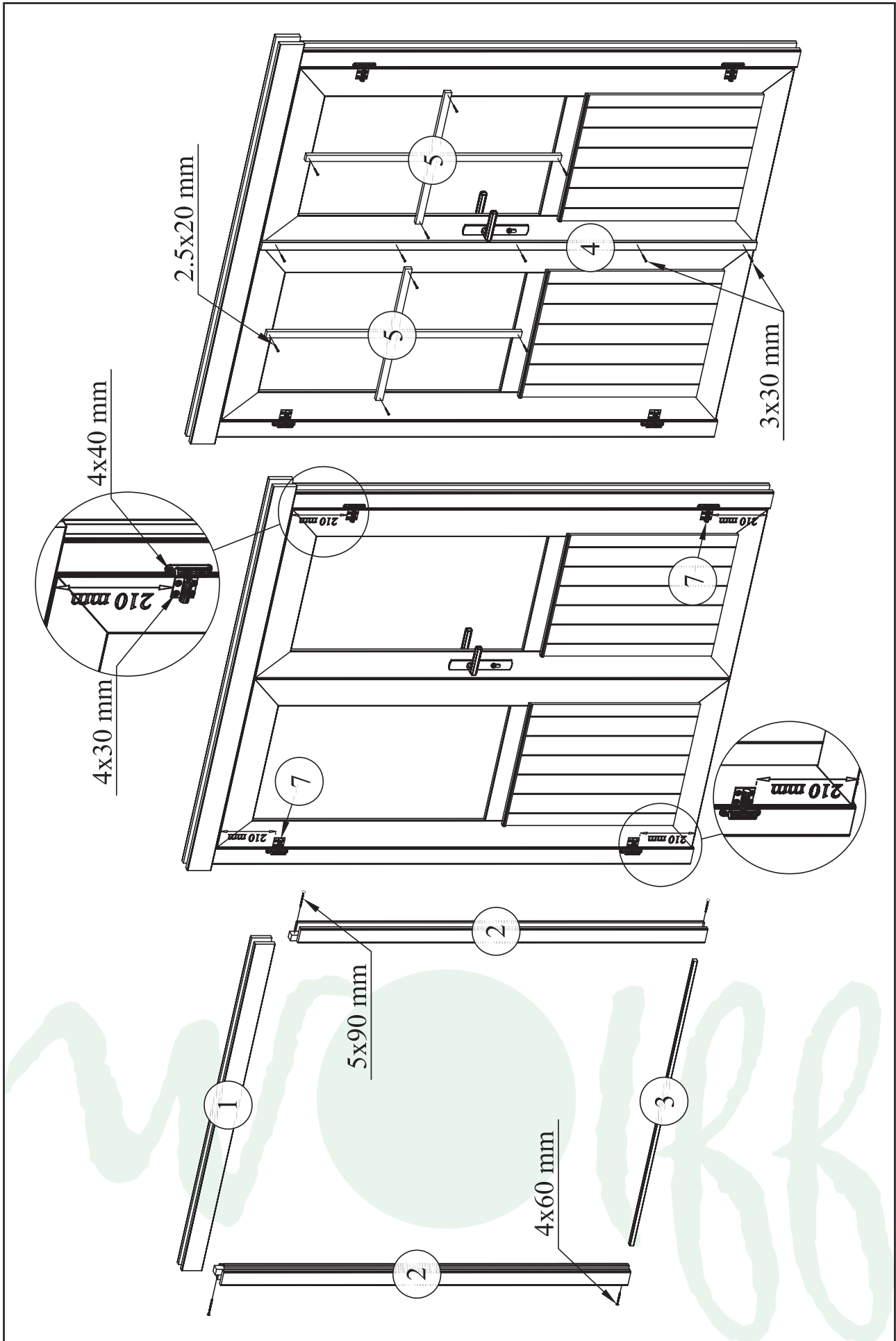

# Detail 3 Lyon C

