

# Technische Daten Lugano 42-B

Wandaußenmaß: 414 x 414 cm

Bohlenstärke: 42 mm



Kontrolliert durch:

Achtung: Alle angegebenen Maße sind ca.-Maße!

# 3D-Darstellung und Grundriss Lugano 42-B

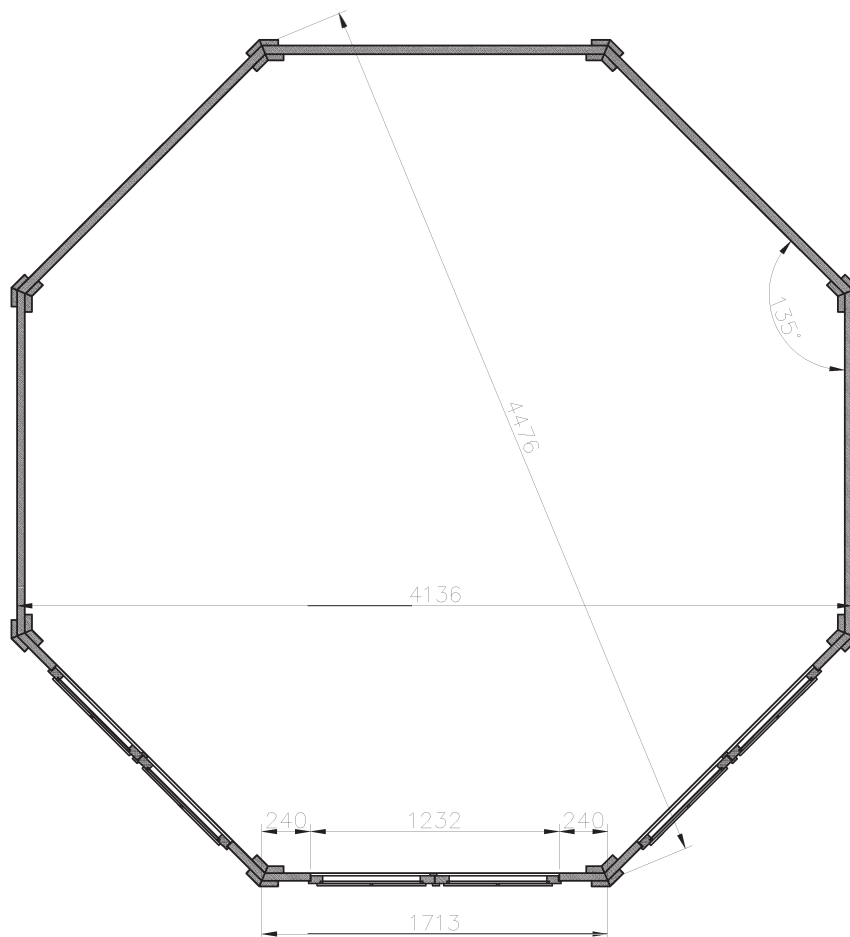
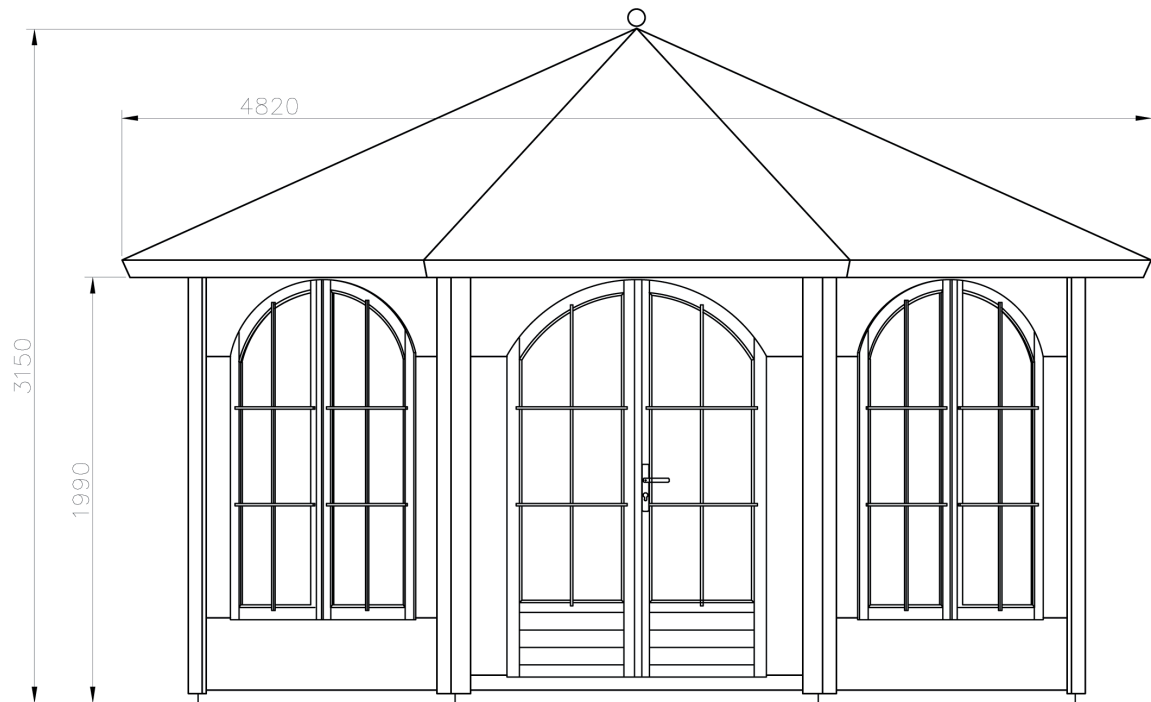

# Lagerholzplan und Fundamentplan Lugano 42-B

Wir empfehlen als Fundament für Ihr Gartenhaus eine vollflächig, festgegründete gepflasterte oder betonierte Fläche.  
Wahlweise ist auch ein Punkt- oder Streifenfundament möglich.

Haustyp	Anzahl der Fundamenthölzer (B x H x L)
Lugano B	Fundamentholz 1: 8 (45 x 65 x 1700 mm) Fundamentholz 2: 2 (45 x 65 x 1437 mm) Fundamentholz 3: 6 (45 x 65 x 1986 mm) Fundamentholz 4: 3 (45 x 45 x 600 mm)

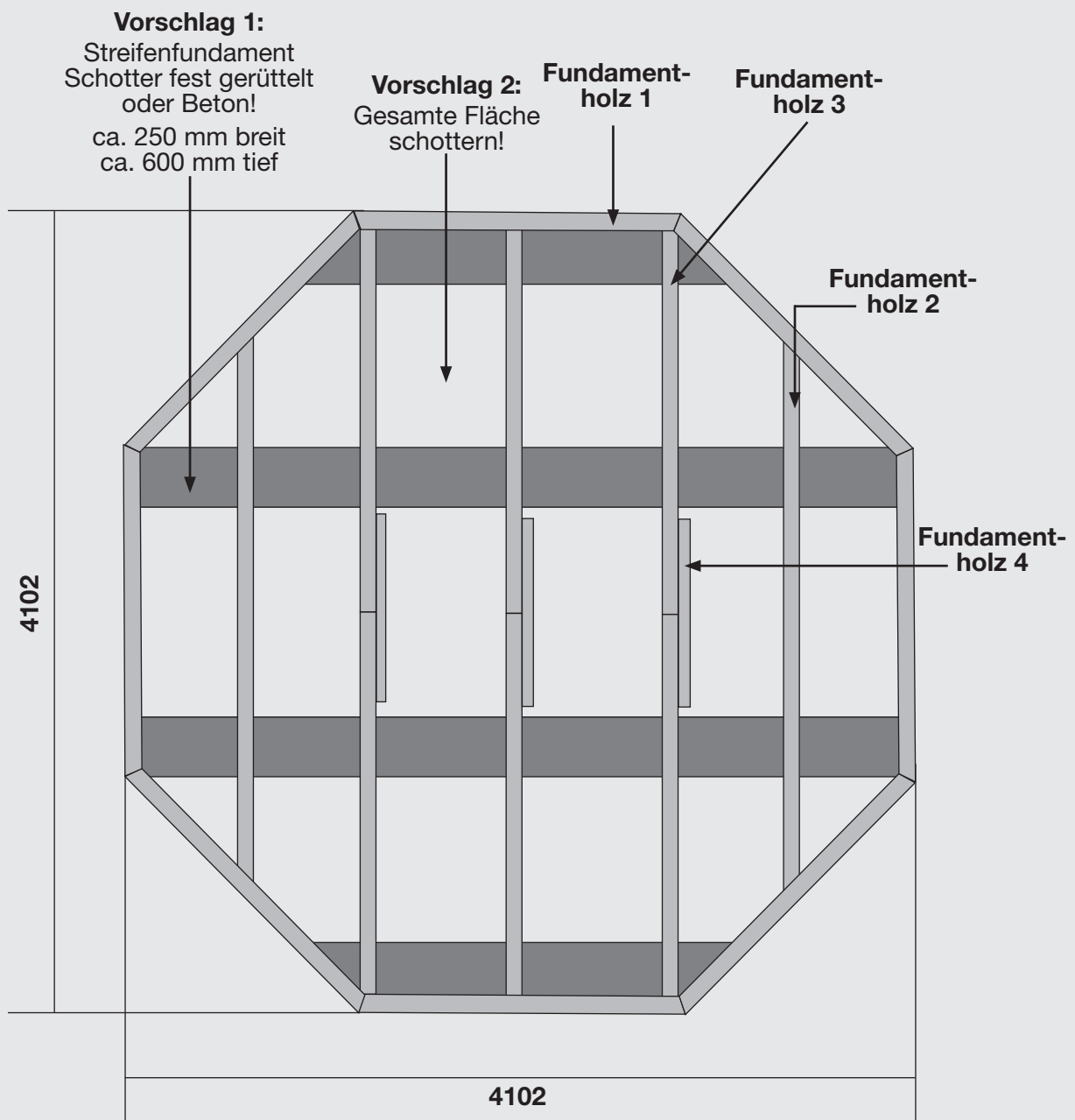







# Teileliste 1

## Lugano 42-B

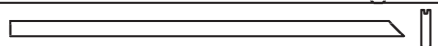
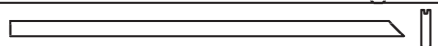
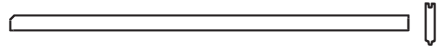
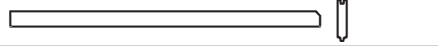
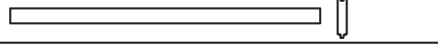
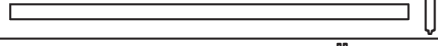
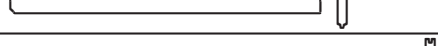
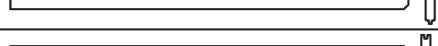
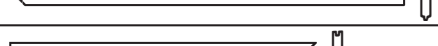
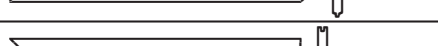
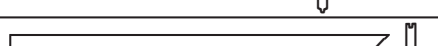
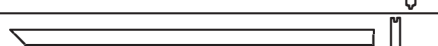
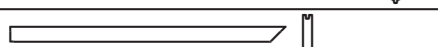
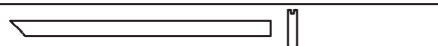
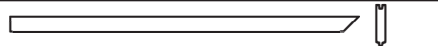
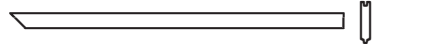
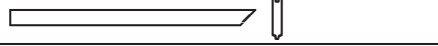
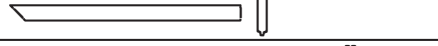
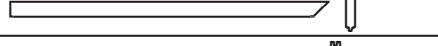
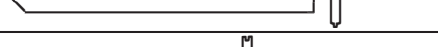
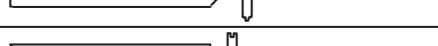
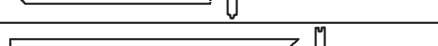
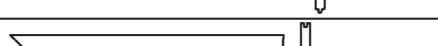

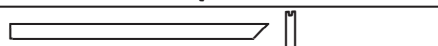
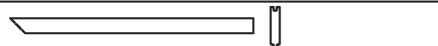

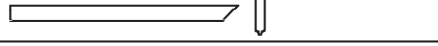
Nr			profile (mm)	pcs.
1	Fundament		45x65x1700	8
2	Fundament		45x65x1437	4
3	Fundament		45x65x1986	8
4	Fundament		45x45x600	6
5	Fussbodenbrett		21x90	
5.1			21x40x1779	1
5.2			21x90x723	1
5.2.1			21x90x1228	1
5.3			21x90x1315	1
5.3.1			21x90x810	1
5.4			21x90x897	1
5.4.1			21x90x1402	1
5.5			21x90x1490	1
5.5.1			21x90x983	1
5.6			21x90x1070	1
5.6.1			21x90x1578	1
5.7			21x90x1663	1
5.7.1			21x90x1159	1
5.8			21x90x1245	1
5.8.1			21x90x1752	1
5.9			21x90x1840	1
5.9.1			21x90x1332	1
5.10			21x90x1418	1
5.10.1			21x90x1926	1
5.11			21x90x2012	1
5.11.1			21x90x1505	1
5.12			21x90x1592	1
5.12.1			21x90x2099	1
5.13			21x90x2186	1
5.13.1			21x90x1678	1
5.14			21x90x1764	1

# Teileliste 2

## Lugano 42-B

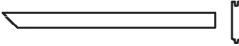
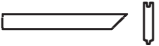
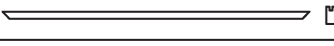
Nr		profile (mm)	pcs.
5.14.1		21x90x2274	1
5.15		21x90x2300	1
5.15.1		21x90x1790	1
5.16		21x90x1790	18
5.16.1		21x90x2300	18
5.17		21x90x1790	1
5.17.1		21x90x2300	1
5.18		21x90x2274	1
5.18.1		21x90x1764	1
5.19		21x90x1678	1
5.19.1		21x90x2186	1
5.20		21x90x2099	1
5.20.1		21x90x1592	1
5.21		21x90x1505	1
5.21.1		21x90x2012	1
5.22		21x90x1926	1
5.22.1		21x90x1418	1
5.23		21x90x1332	1
5.23.1		21x90x1840	1
5.24		21x90x1752	1
5.24.1		21x90x1245	1
5.25		21x90x1159	1
5.25.1		21x90x1663	1
5.26		21x90x1578	1
5.26.1		21x90x1070	1
5.27		21x90x983	1
5.27.1		21x90x1490	1
5.28		21x90x1402	1
5.28.1		21x90x897	1
5.29		21x90x810	1
5.29.1		21x90x1315	1

# Teileliste 3 Lugano 42-B

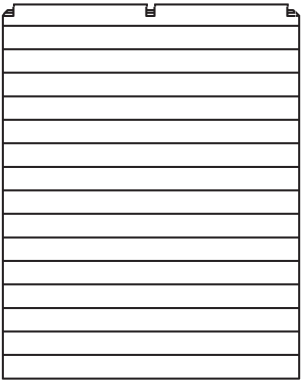
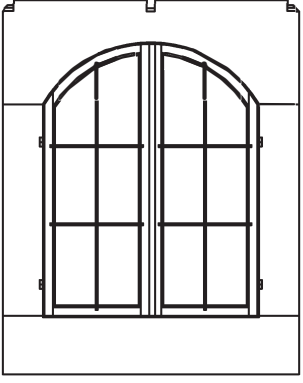
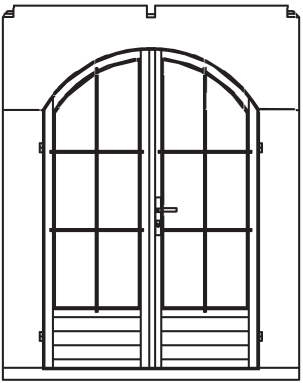
Nr		profile (mm)	pcs.
5.30		21x90x1228	1
5.30.1		21x90x1723	1
5.31		21x40x1779	1
6	Abdeckleiste 	27x90x2087	16
7	Dachstützleiste 	16x90x785	16
8	Dachblende 	16x90x1989	8
9	Wandelement 	73x1713x2163	5
10A	Fensterelement zum öffnen 	73x1713x2163	2
11	Türelement 	73x1713x2163	1
12	Dachelement	62x1970x2450	8

# Teileliste 4 Lugano 42-B

Nr		profile (mm)	pcs.
13	Deckelement		1
14	Dachhaube		1
15	Zylinderschloss		1
16	Türbeschlag		1
17	Fenstergriff		4
18	Fensterfeststeller		2
19	Schraube	3x25	60
20	Schraube	3x35	56
21	Schraube	4,5x70	28
22	Schraube	4x50	64
23	Schraube	5x90	100
24	Schraube	6x120	16
25	Nagel	2,1x50	350
26	Dachpappnagel	2,5x20	450
27	Schraube	4,8x25	4



# Wandpläne Lugano 42-B

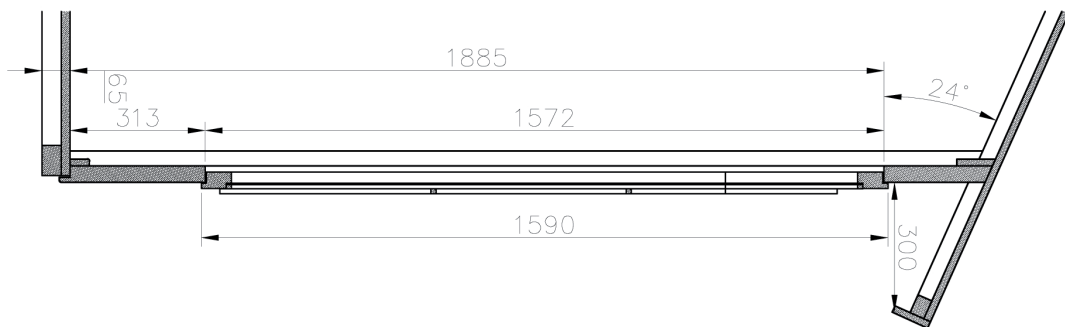
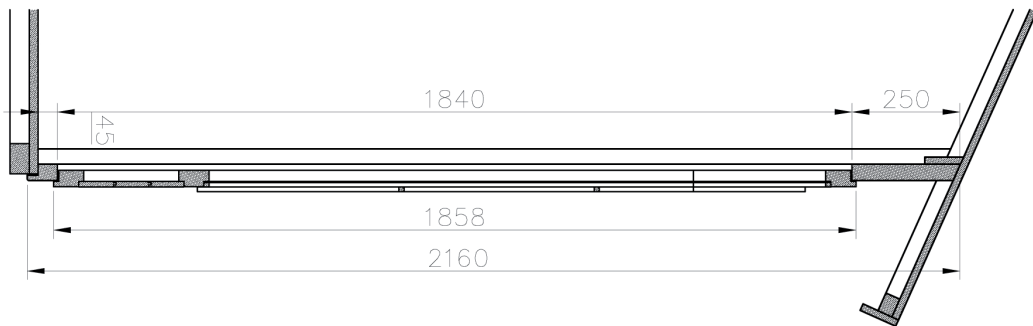
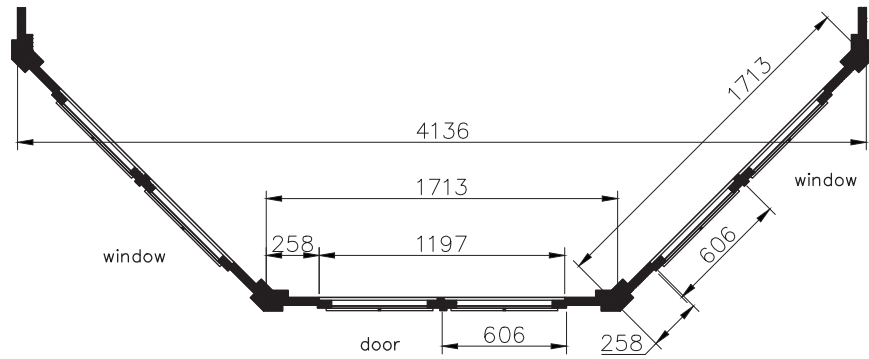



# Fußbodenverlegung Lugano 42-B

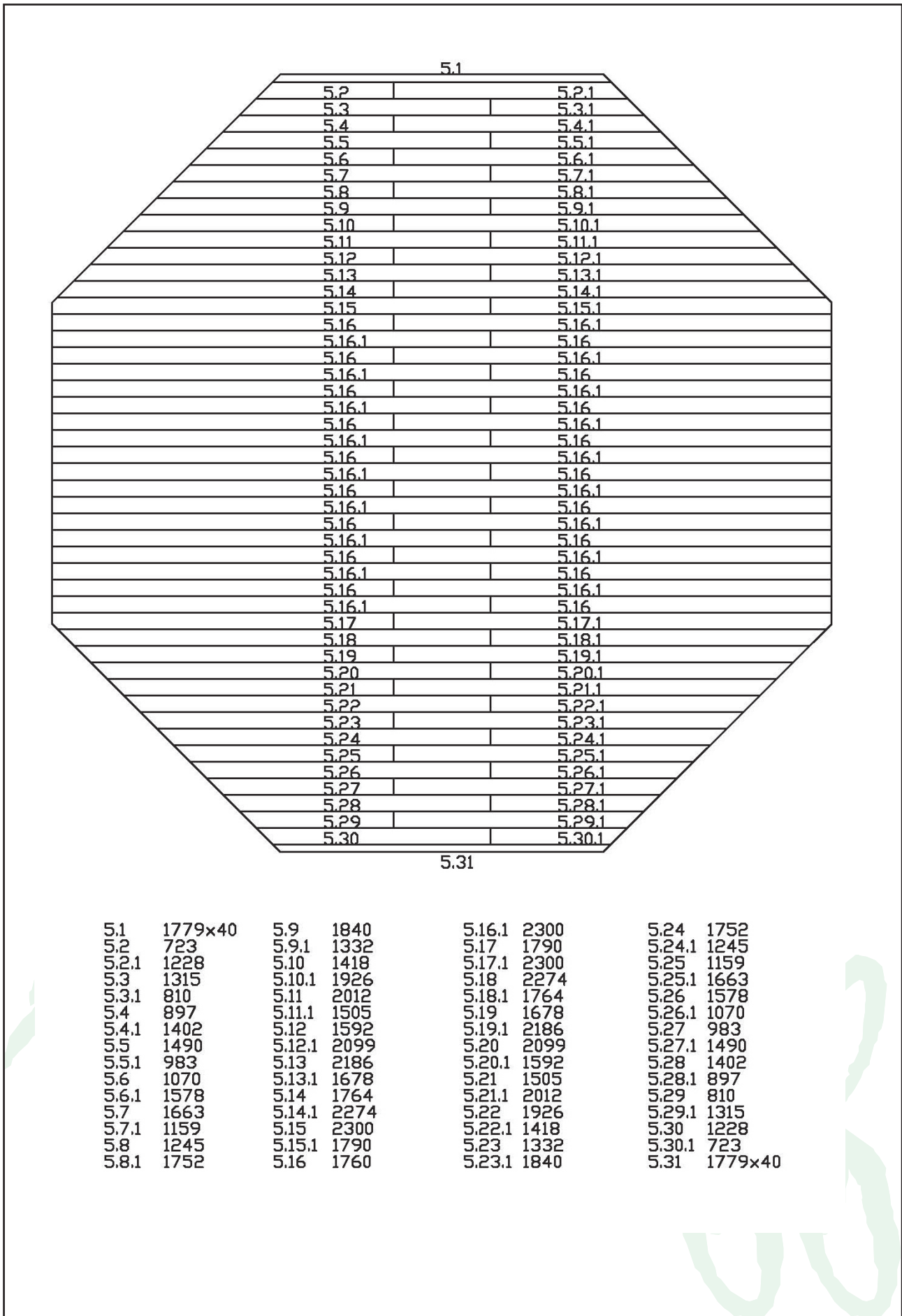

5.1	1779x40	5.9	1840	5.16.1	2300	5.24	1752
5.2	723	5.9.1	1332	5.17	1790	5.24.1	1245
5.2.1	1228	5.10	1418	5.17.1	2300	5.25	1159
5.3	1315	5.10.1	1926	5.18	2274	5.25.1	1663
5.3.1	810	5.11	2012	5.18.1	1764	5.26	1578
5.4	897	5.11.1	1505	5.19	1678	5.26.1	1070
5.4.1	1402	5.12	1592	5.19.1	2186	5.27	983
5.5	1490	5.12.1	2099	5.20	2099	5.27.1	1490
5.5.1	983	5.13	2186	5.20.1	1592	5.28	1402
5.6	1070	5.13.1	1678	5.21	1505	5.28.1	897
5.6.1	1578	5.14	1764	5.21.1	2012	5.29	810
5.7	1663	5.14.1	2274	5.22	1926	5.29.1	1315
5.7.1	1159	5.15	2300	5.22.1	1418	5.30	1228
5.8	1245	5.15.1	1790	5.23	1332	5.30.1	723
5.8.1	1752	5.16	1760	5.23.1	1840	5.31	1779x40