

# Nancy

Wandaußenmaß: 450 x 300 cm  
Bohlenstärke: 40 mm



Kontrolliert durch:

Achtung: Alle angegebenen Maße sind ca.-Maße!

# 3D-Ansicht Nancy

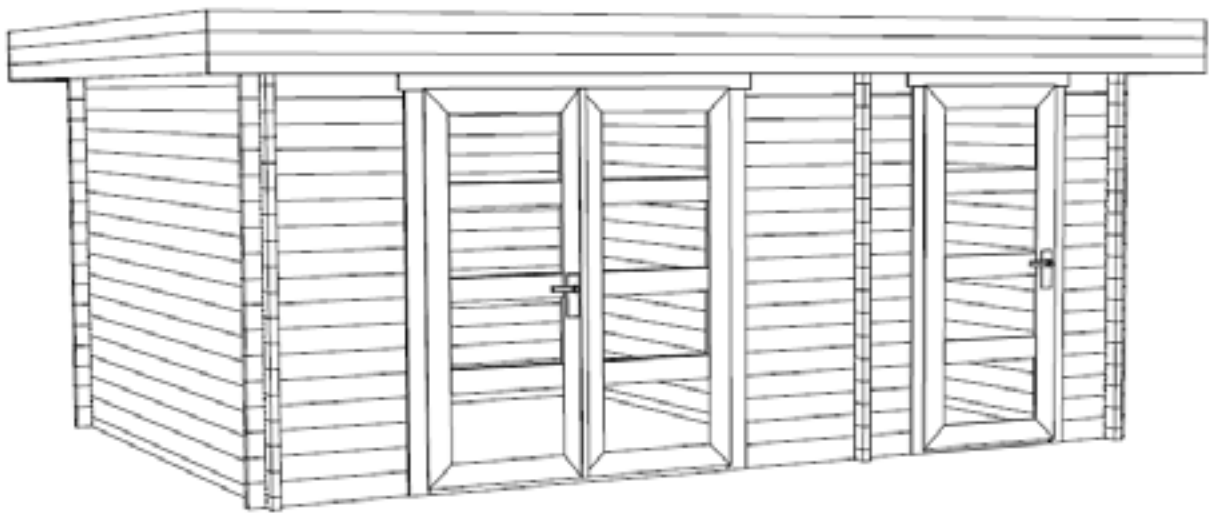

# Grundriss 1 Nancy

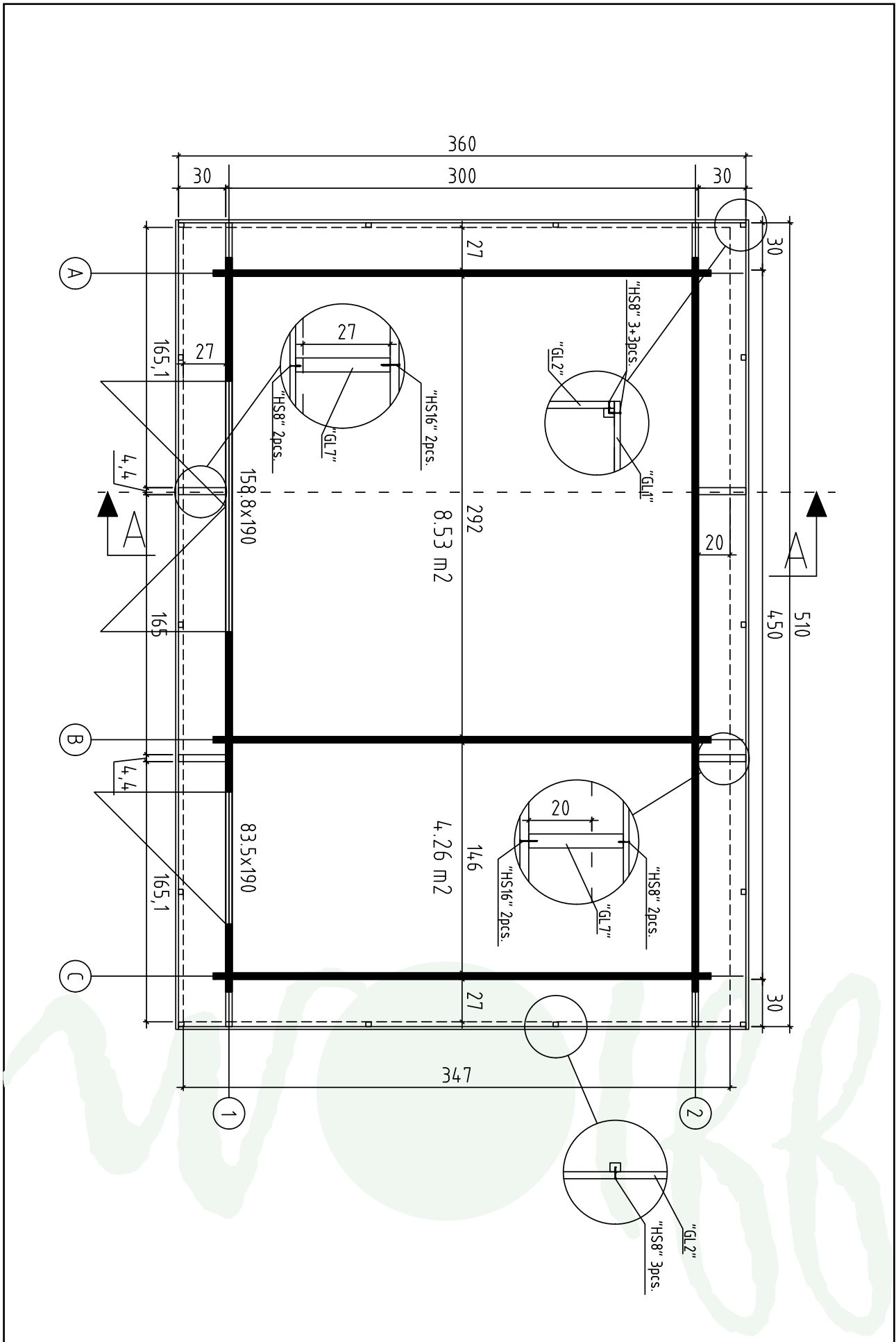

# Grundriss 2 Nancy

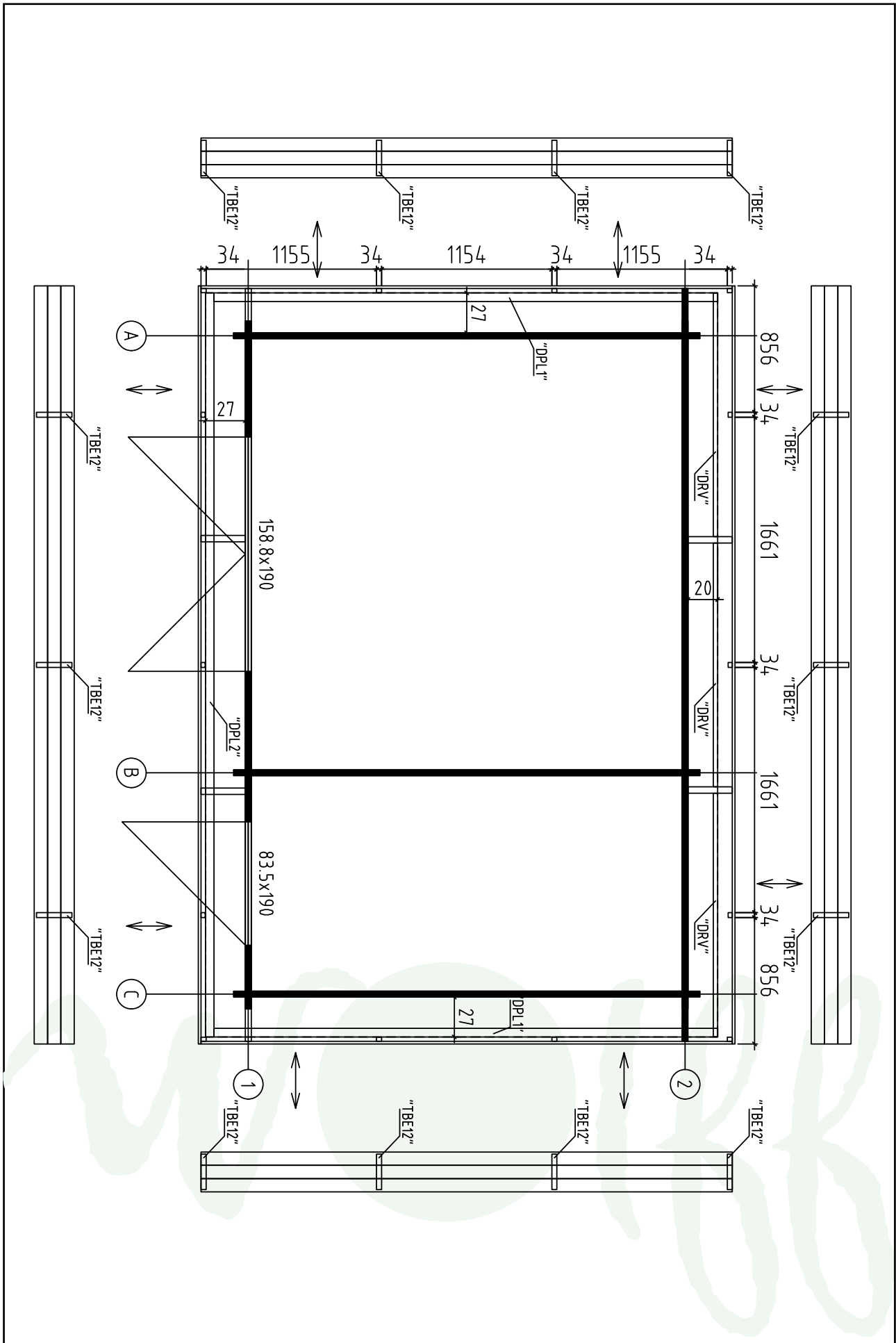



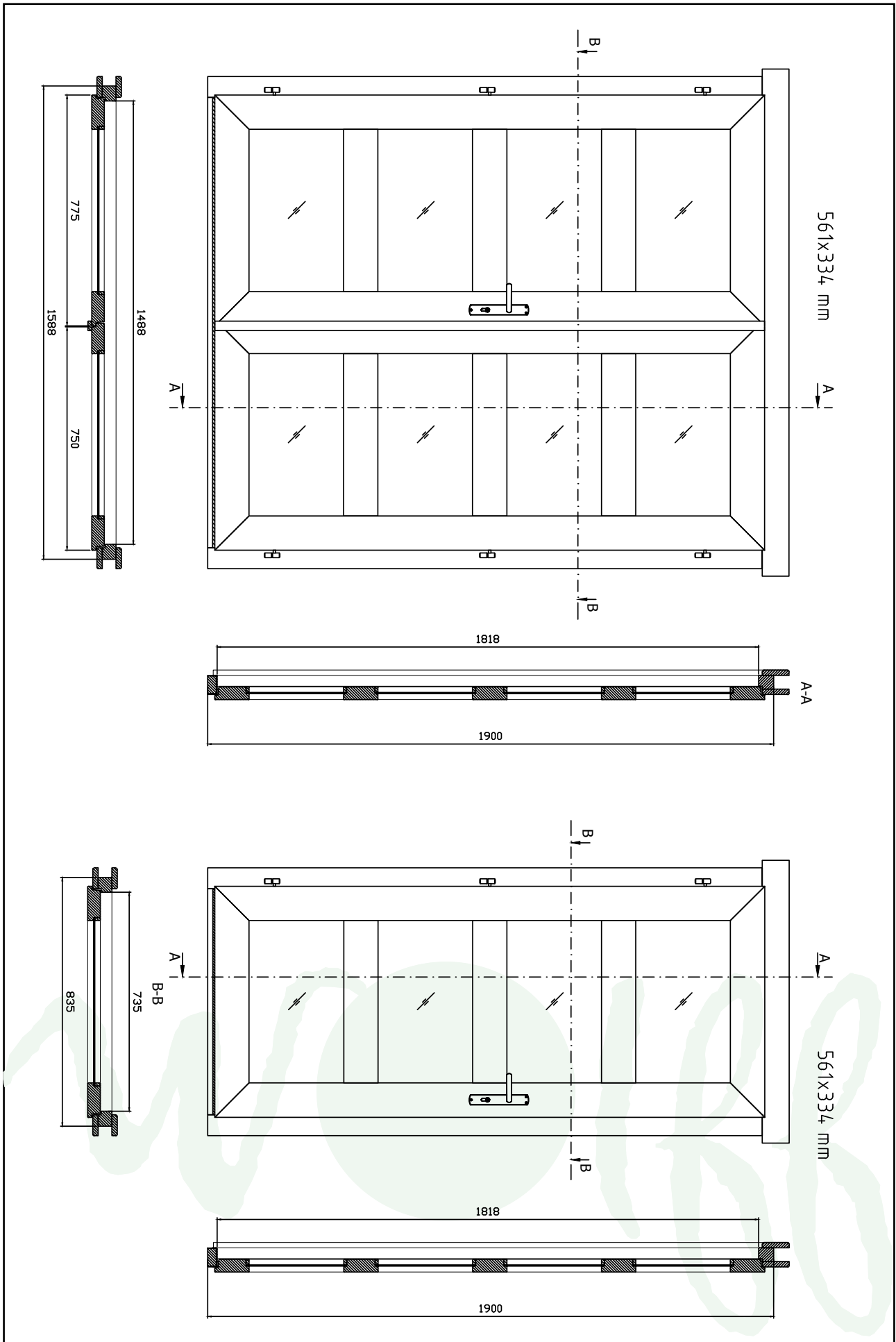





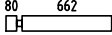
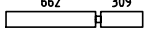

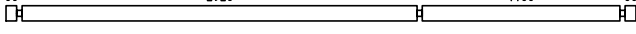
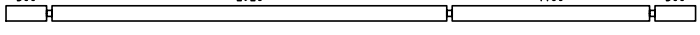
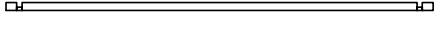
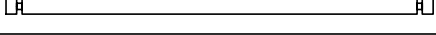
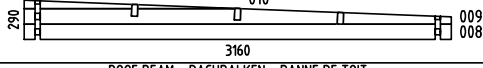
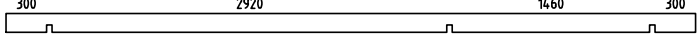
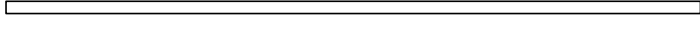
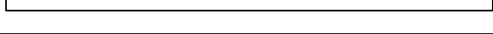
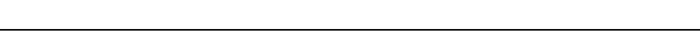
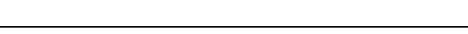

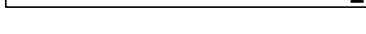

# Fenster- und Türdetails Nancy













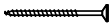

# Teilleiste 1

## Nancy

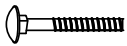
Pos		Q	P (mm)	L (mm)
001		17	40x114	782
002		17	40x114	1011
003		17	40x114	428
004		18	40x114	4660
005		2	40x114	5100
006		3	40x57	3160
007		4,8	40x114	3160
WA-1 WB-1 WC-1	 ROOF BEAM - DACHBALKEN - PANNE DE TOIT	1 1 1		
PR21	 GABLE MOULDING - GIEBELLEISTE - PLANCHE DE RIVE	3	44x140	5100
GL2	 GABLE MOULDING - GIEBELLEISTE - PLANCHE DE RIVE	6	18x90	5136
GL1	 GABLE MOULDING - GIEBELLEISTE - PLANCHE DE RIVE	6	18x90	3600
DPL2	 ROOFING FELT FILLET - DACHPAPPENLEISTE - BAGUETTE DE FIXATION DU FEUTRE BITUMEUX	1	58x18	5040
DPL1	 ROOFING FELT FILLET - DACHPAPPENLEISTE - BAGUETTE DE FIXATION DU FEUTRE BITUMEUX	2	58x18	3412
RB	ROOF BOARDS - DACHBRETTER - VOLIGES 	56	90x18	3473
DRV	ROOF EDGE REINFORCEMENT - DACHRANDVERSTÄRKUNG - CORNIERE DE RENFORT DE BORD DE TOIT 	3	28x34	1650
KFS-1	STORM PROTECTION - STURMLEISTE - LATTE ANTI-TEMPETE 	2	22x45	2050
KFS-2	STORM PROTECTION - STURMLEISTE - LATTE ANTI-TEMPETE 	2	22x45	2500
TBE12	FIXING SLAT FOR DISTANCE SPACERS - BEFESTIGUNGSLEISTE - RENFORTS PLANCHES DE RIVES 	14	28x34	240
GL7	DISTANCE SPACERS FOR GABLE MOULDING - DACHSTÜZEN - SUPPORTS EXTENSION TOITURE 	4	44x120	305
HS8	SCREW FOR GABLE MOULDING - SCHRAUBEN FÜR GIEBELLEISTE - VIS DE FIXATION POUR PLANCHE DE RIVE 	70	3,5x35	
HS4	SCREW FOR DOOR FILLET - SCHRAUBE ZUR BEFESTIGUNG TÜRLEISTE - VIS POUR FIXATION BAGUETTE D'ARRET DE PORTE 	5	3x30	
HS12	SCREW FOR ROOF EDGE REINFORCEMENT - SCHRAUBEN FÜR DACHRANDVERSTÄRKUNG - VIS POUR FIXATION CORNIERE RENFORT DE BORD DE TOIT 	26	4x40	
HS18	SCREW FOR ROOF BEAMS - SCHRAUBEN FÜR DACHBALKEN - VIS POUR FIXATION PANNES DE TOIT 	15	5x120	
HS18	SCREW FOR GABLE - SCHRAUBEN FÜR GIEBEL - VIS POUR FIXATION DES PIGNONS 	12	5x120	
HS16	SCREW FOR FIXING GABLE MOULDING DISTANCE SPACERS TO THE WALL - SCHRAUBEN FÜR DACHSTÜZEN - VIS DE SUPPORTS EXTENSION TOITURE 	8	5x90	

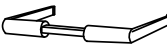
# Teileliste 2

## Nancy

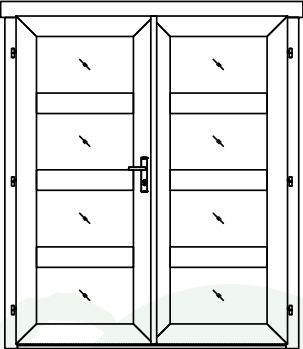
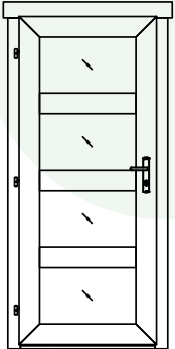
Pos		Q	P (mm)	L (mm)	
HS16	SCREW FOR DOOR JAMB - SCHRAUBE FÜR TÜRRAHMEN - VIS DE FIXATION PARTIE HAUTE AVEC MONTANTS DU CADRE DE PORTE		4	5x90	
HS25	SCREW FOR DOORSTEP - SCHRAUBEN FÜR SWELLE - VIS POUR FIXATION BARRE DE SEUIL		5	4.5x65	
SH40	HAMMER BLOCK - SCHLAGHOLZ - CALLE DE FRAPPE		1		
SFS	NUT FOR STORM PROTECTION - SCHRAUBENMUTTER FÜR STURMLEISTE - ECROU POUR LATTE ANTI-TEMPETE		8	D6	
NF4	ZN NAIL FOR ROOF - ZN NÄGEL FÜR DACHBRETT - POINTE POUR FIXATION VOLIGES DE TOIT		290	2x50	
NF5	ZN NAIL FOR ROOFING FELT FILLET - ZN NÄGEL FÜR DACHPAPPENLEISTE - POINTE POUR BAGUETTE DE FIXATION FEUTRE BITUMEUX		35	2x40	
BFS	BOLT FOR STORM PROTECTION - BOLZEN FÜR STURMLEISTE - BOULON POUR LATTE ANTI-TEMPETE		8	6x70	
DFS	WASHER FOR STORM PROTECTION - DICHTSCHEIBE FÜR STURMLEISTE - RONDELLE POUR LATTE ANTI-TEMPETE		8	D6	
TL4	DOOR HANDLE FITTINGS - TÜRRGRIFF - POIGNEE DE PORTE		2		
TL5	SET OF DOOR LOCK COVERS - SCHLOSSBLENDEN - SET DE GARNITURES DE PORTE		2		
	CYLINDER LOCK - ZYLINDERSCHLOSS - BARILLET DE PORTE		2	30x35	
	MALE BOLT HINGE FOR DOOR - TÜRRIEGEL - PARTIE MALE DE PAUMELLE DE PORTE		6		
	STRIKER FOR BARREL BOLT - HÜLSE FÜR GRENDRIEGEL - GACHE AU SOL DU TARGETTE		2		
	DOOR - TÜR - PORTE 1588x1900 MILCHGLAS		TUK.4.020.MVV.MMb MGC	1	
	DOOR - TÜR - PORTE 835x1900 MILCHGLAS		UK.4.020.MVV.MMb MGC	1	

# Wandplan 1 Nancy

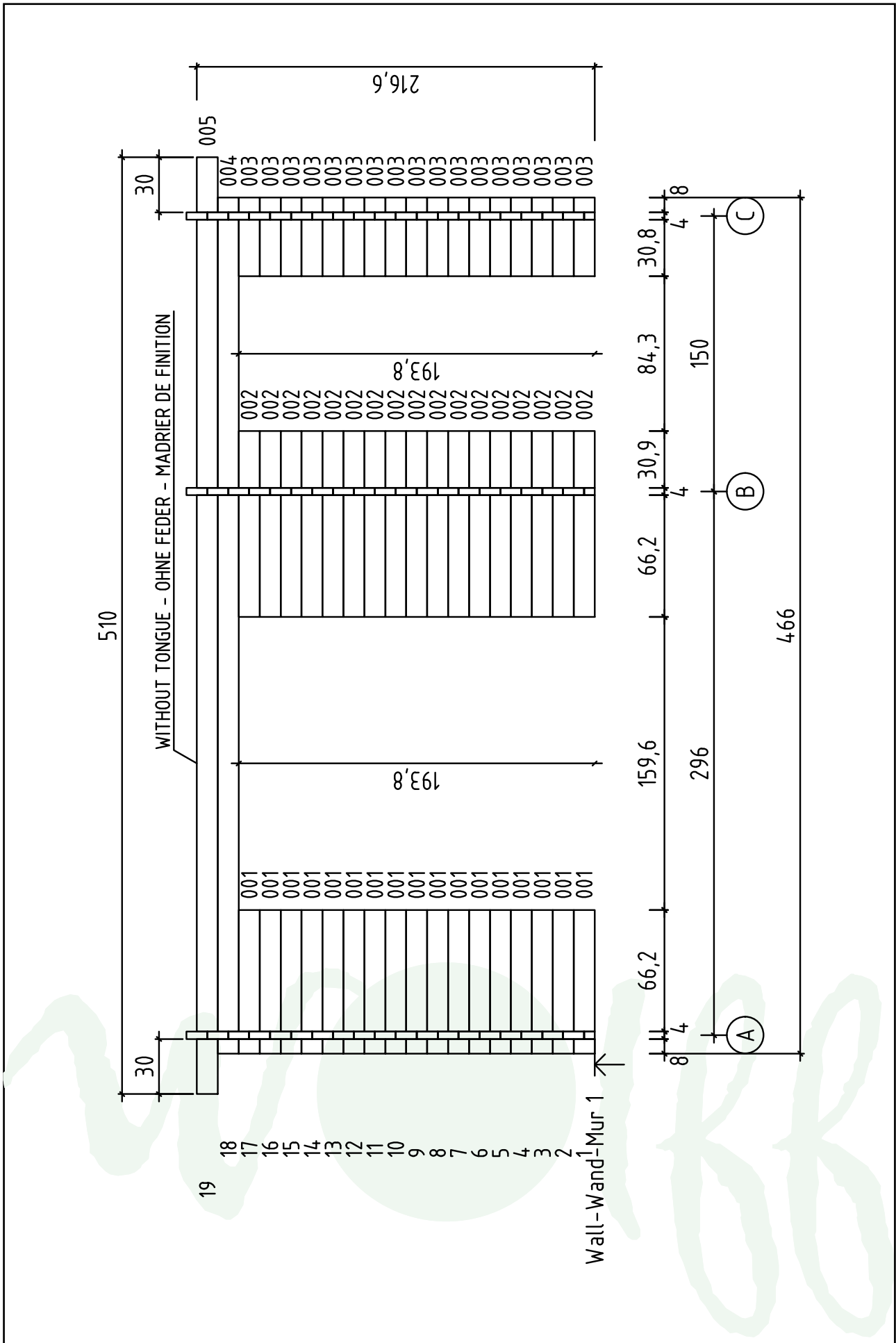



# Wandplan 2 Nancy

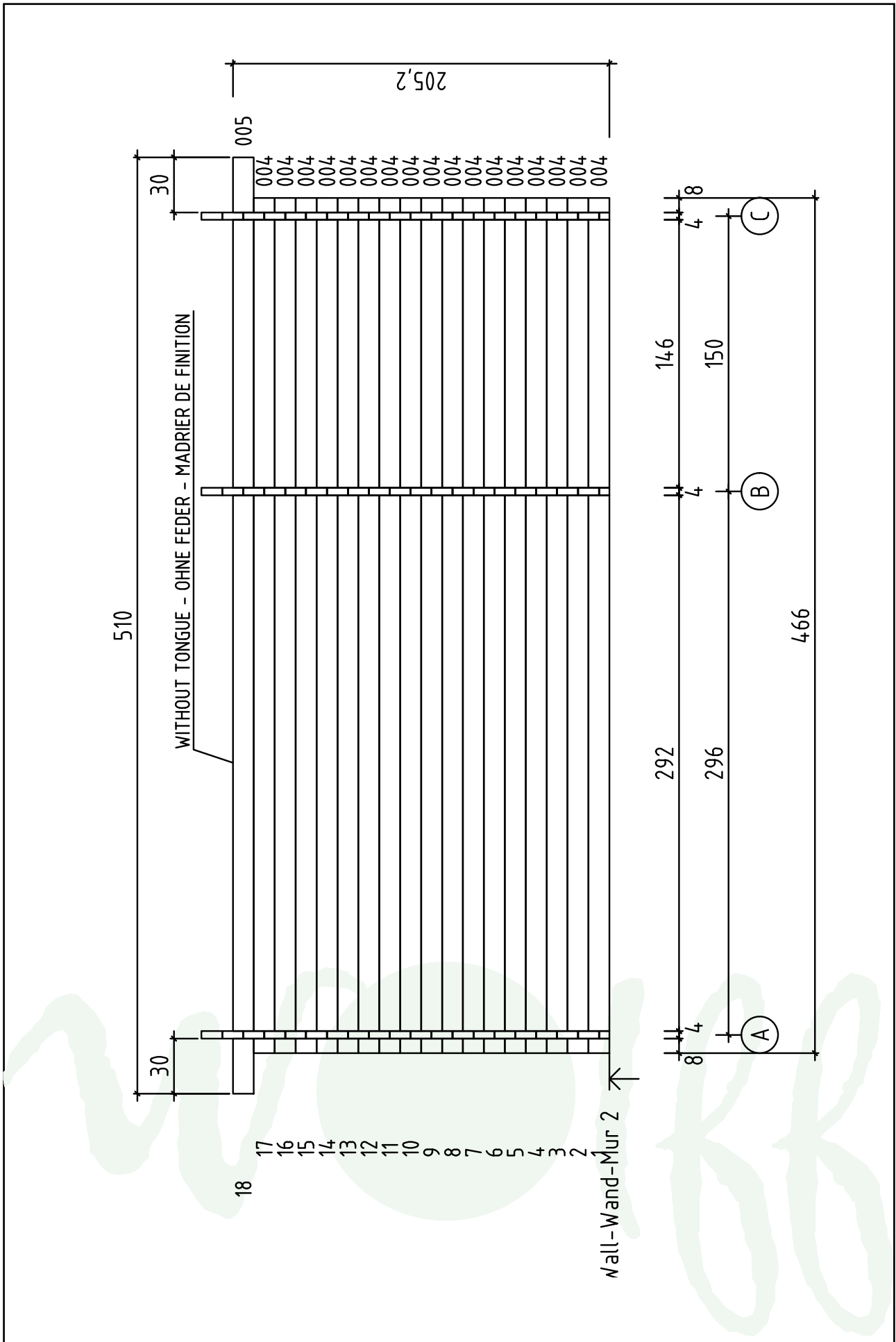

# Wandplan A Nancy

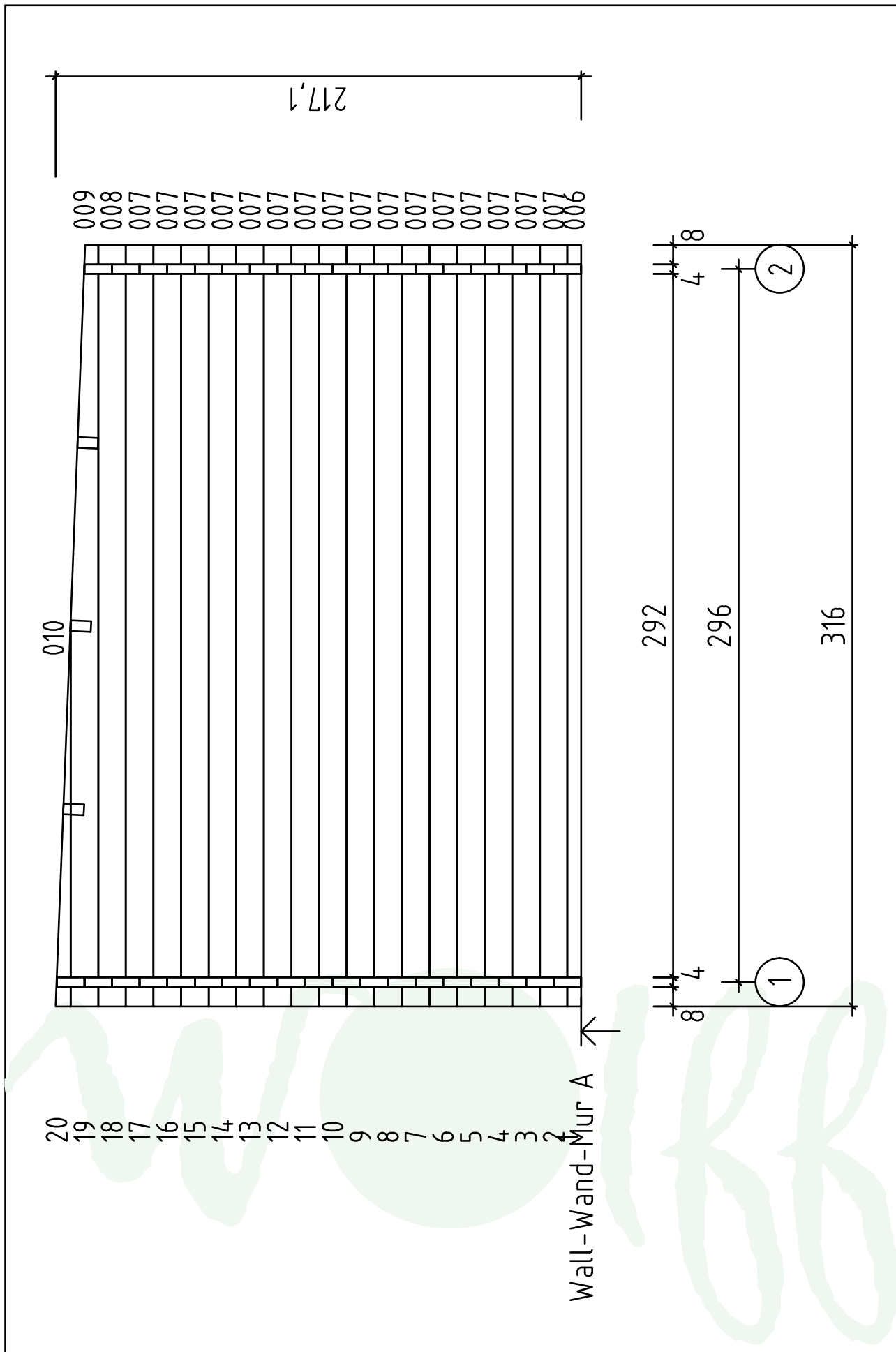

# Wandplan B Nancy

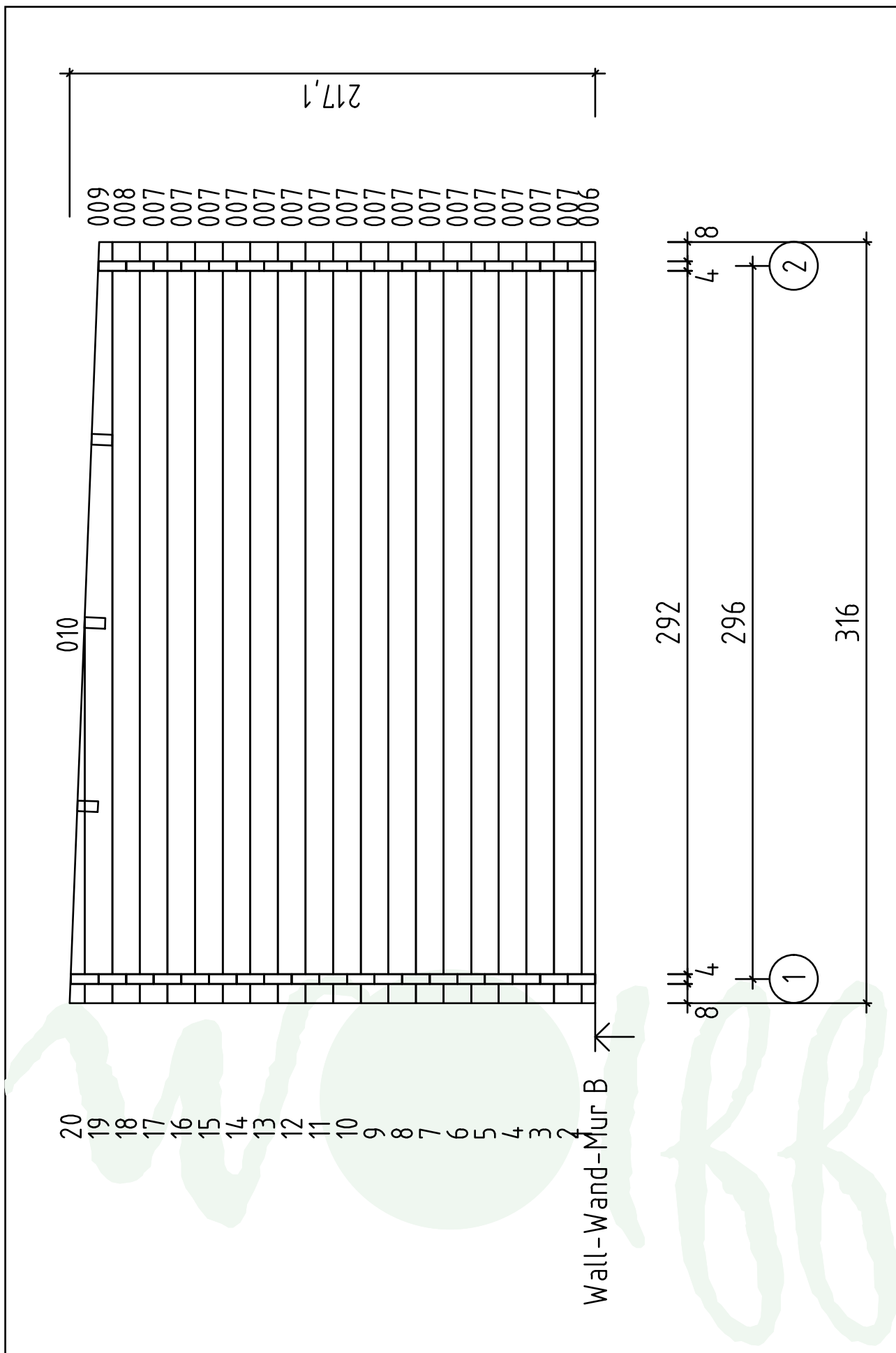

# Wandplan C Nancy

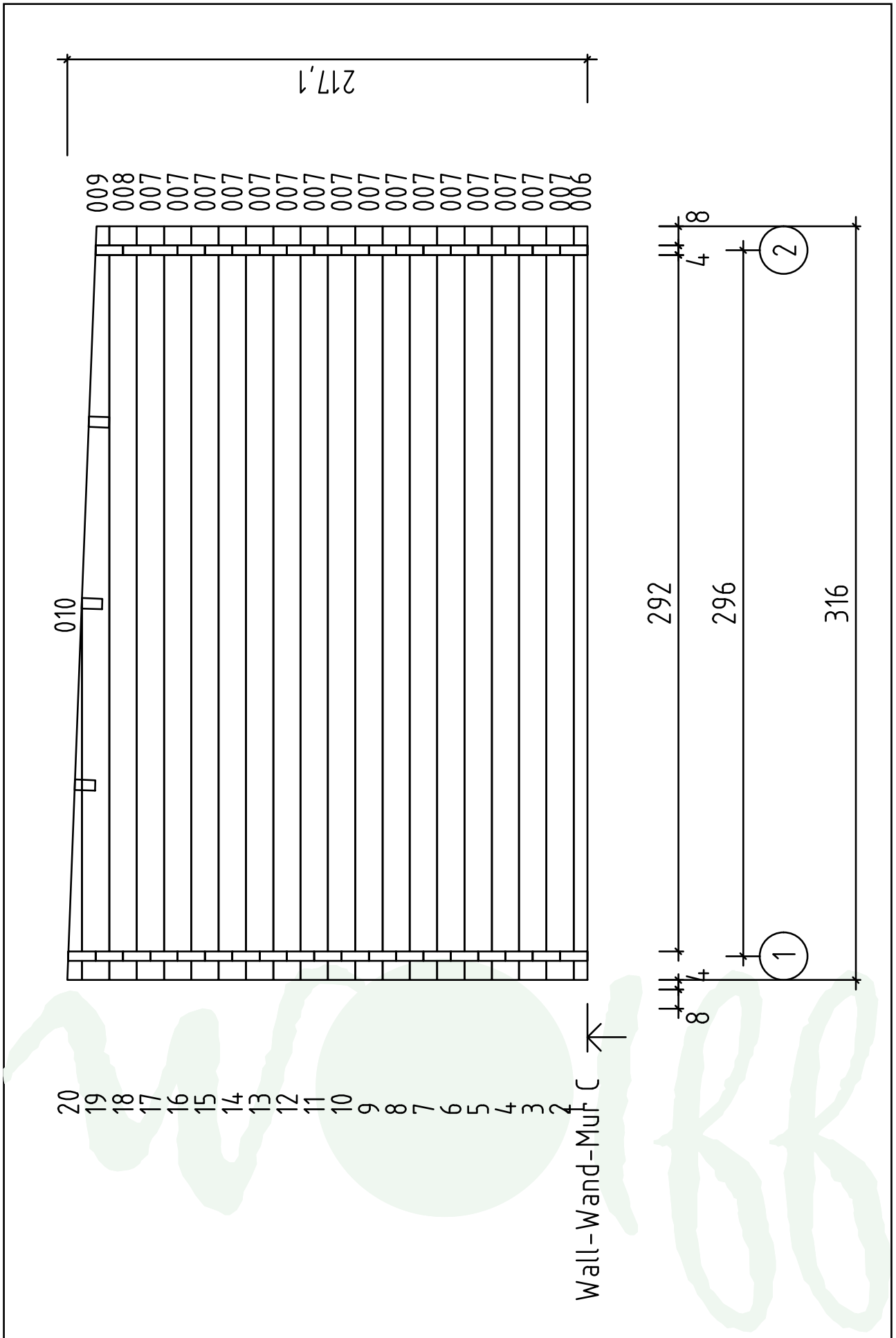

# Wandplan D Nancy

