

Nina 28-B mit Terrasse

Wandaußenmaß: 580 x 280 cm

Bohlenstärke: 28 mm



**Dieses Haus lässt sich auch spiegelverkehrt aufbauen.
Darum ist es erforderlich, die Fußbodenbretter im Eingangsbereich
laut beigefügter Zeichnung selbst zuzuschneiden.**

Kontrolliert durch:

Achtung: Alle angegebenen Maße sind ca.-Maße!

3D-Darstellung Nina 28-B mit Terrasse

Das Haus Nina B lässt sich auch spiegelverkehrt aufbauen. Darum ist es erforderlich, die Fußbodenbretter im Eingangsbereich laut beigefügter Zeichnung selbst zuzuschneiden.

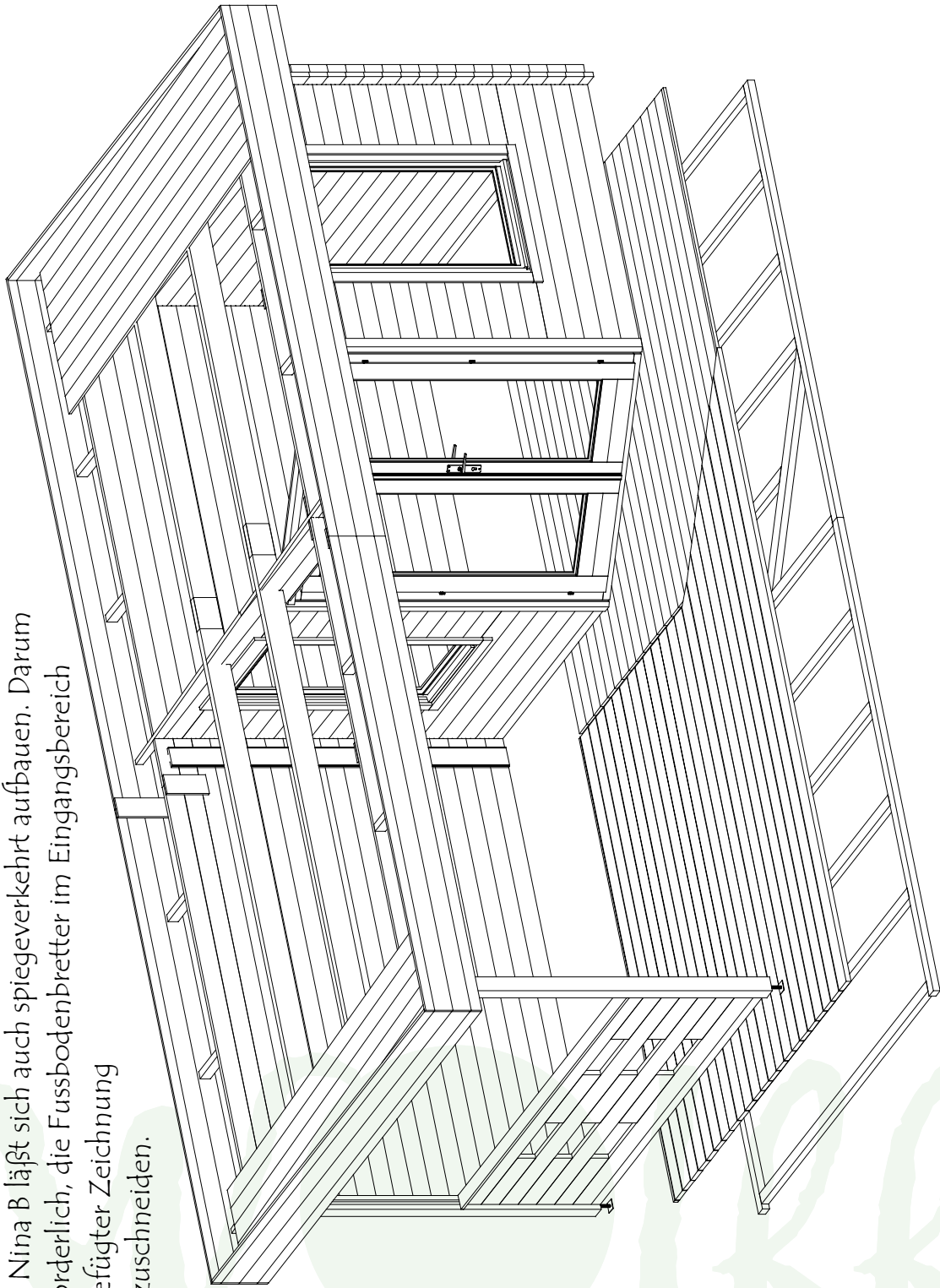

Grundriss Nina 28-B mit Terrasse

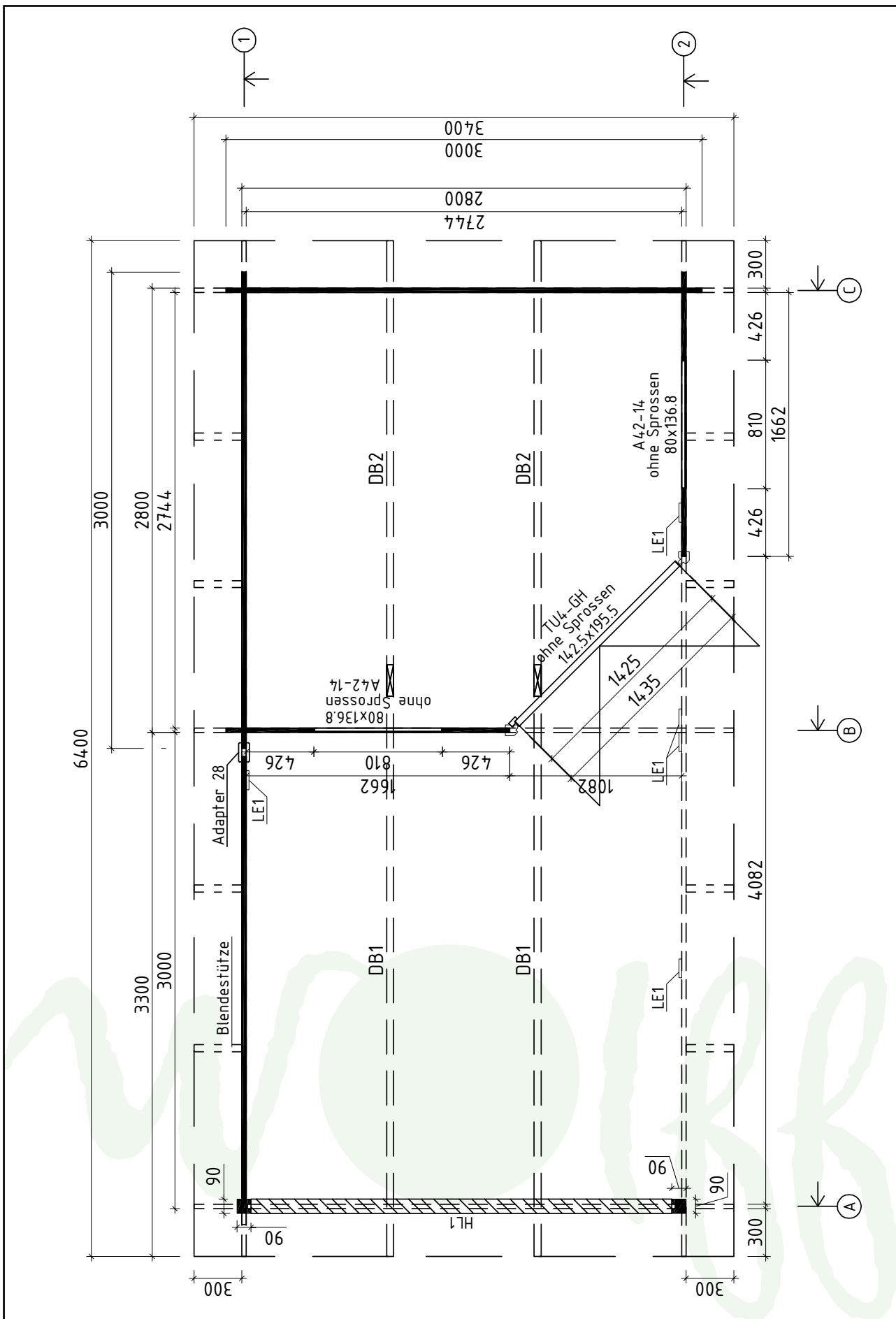





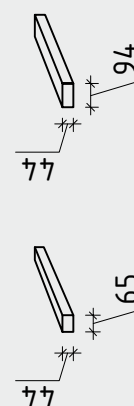
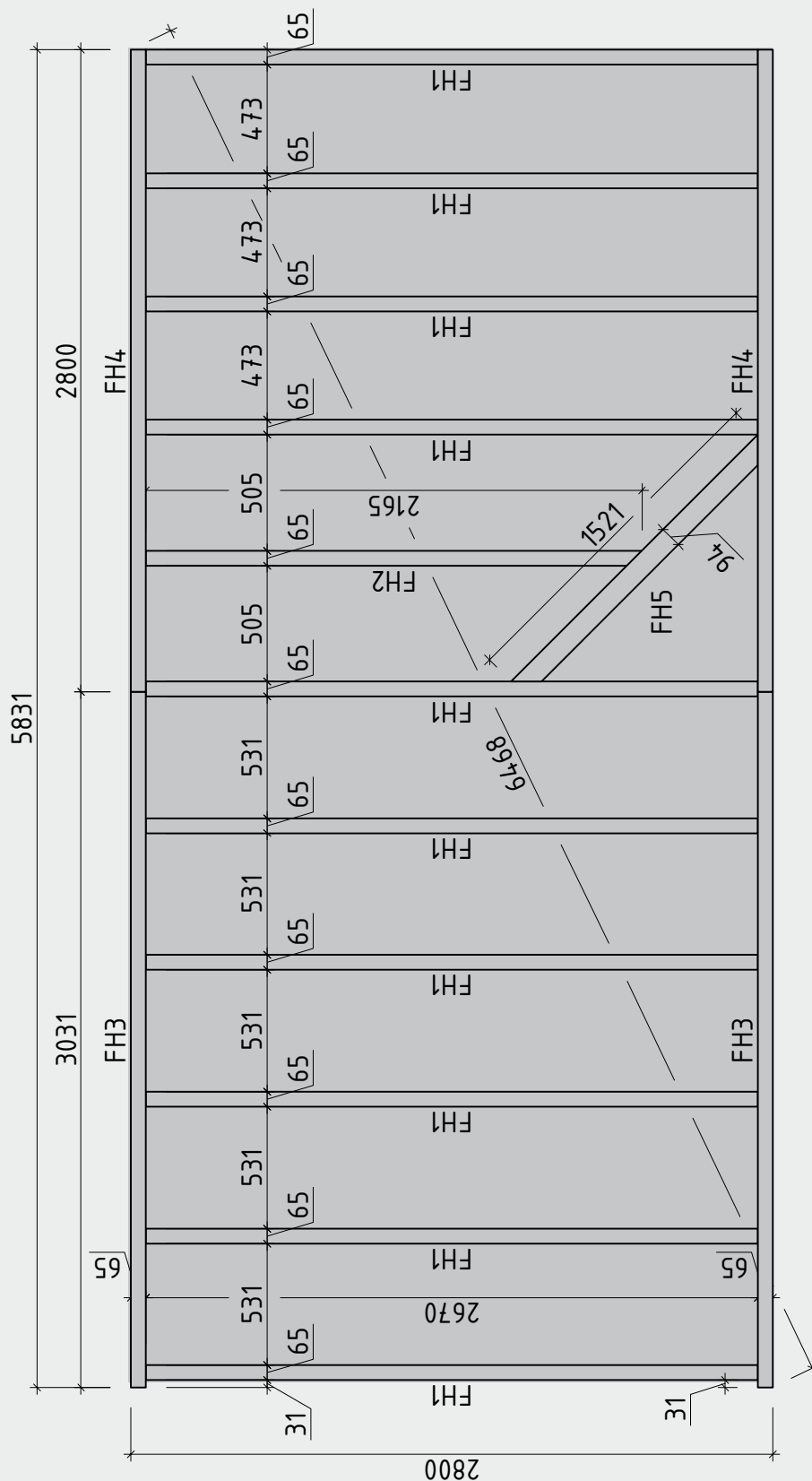



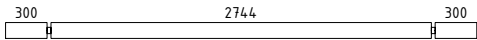
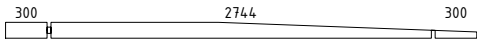
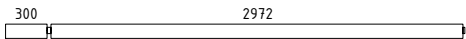
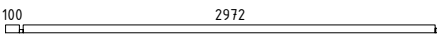
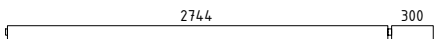
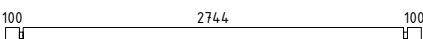
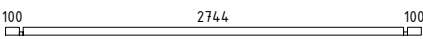
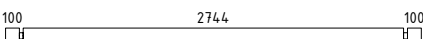
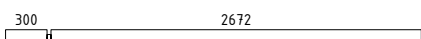
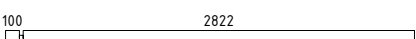
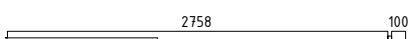

Lagerholzplan und Fundamentplan Nina 28-B mit Terrasse

Wir empfehlen als Fundament für Ihr Gartenhaus eine vollflächig festgegründete, gepflasterte oder betonierte Fläche.
Wahlweise ist auch ein Punkt- oder Streifenfundament möglich.

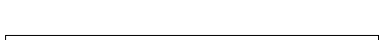
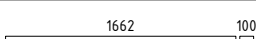

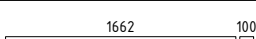
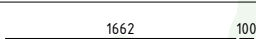
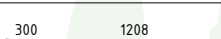
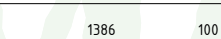





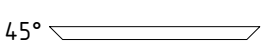

Teileliste 1

Nina 28-B mit Terrasse

001		1	28x114	4486
002		1	28x114	3400
003		3	28x114	3400
004		1	28x103	3314
005		1	28x57	3114
006		1	28x103	3086
007		37	28x114	3000
008		1	28x57	3000
009		1	28x114	3000
010		1	28x114	3000
011		1	28x114	2950
012		1	28x114	2886
013		17	28x114	2811
014		1	28x114	2691
015		3	28x114	2691
016		1	28x57	2691
017		5	28x114	1790
018		1	28x114	1790
019		4	28x114	1790
020		1	28x57	1790
021		3	28x57	1536
022		1	28x114	1514
023		9	28x114	600
024		24	28x114	554
025		12	28x114	396
026		12	28x114	396



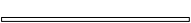
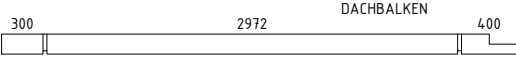
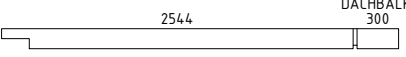

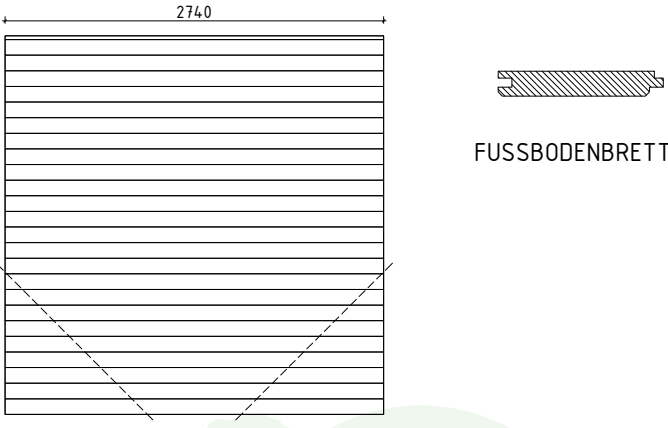
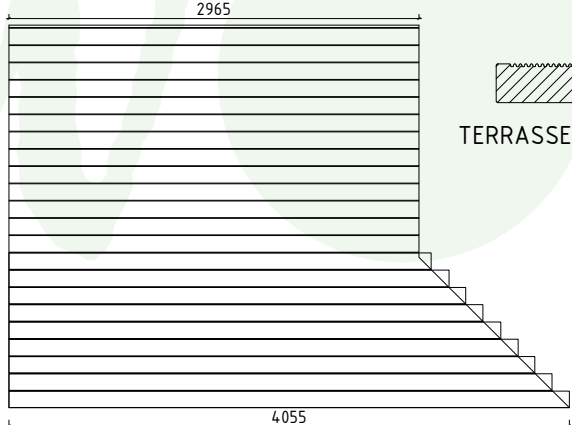







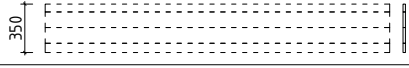
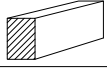

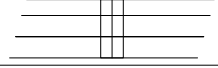

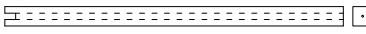

Teileliste 2

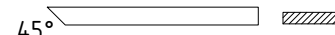
Nina 28-B mit Terrasse

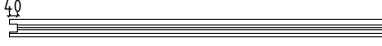
Pos		Stck	Profil (mm)	Länge (mm)
FH5	 FUNDAMENTHÖLZER (imprägniert)	1	94x44	1521
FH3	 FUNDAMENTHÖLZER (imprägniert)	2	65x44	3031
FH4	 FUNDAMENTHÖLZER (imprägniert)	2	65x44	2800
FH1	 FUNDAMENTHÖLZER (imprägniert)	10	65x44	2670
FH2	 FUNDAMENTHÖLZER (imprägniert)	1	65x44	2165
HL1	 HANDLAUF	✓ 1	90x18	2651
LE1	 LEISTE	5	120x18	264
LE2	 LEISTE	4	15x28	1358
DB1	 DACHBALKEN	2	44x145	3728
DB2	 DACHBALKEN	2	44x145	2872
	DACHBRETTER 	57+1	113x18	3300
Diese Haus läßt sich auch spiegelvehrkert aufbauen. Darum ist es erforderlich, die Fussbodenbretter im Eingangsbereich laut beigefügter Zeichnung selbst zuzuschneiden.				
	 FUSSBODENBRETTER	1	113x18	25+1
			oder	L-2740
		1	88x18	33+1
Diese Haus läßt sich auch spiegelvehrkert aufbauen. Darum ist es erforderlich, die Terrassenbretter im Eingangsbereich laut beigefügter Zeichnung selbst zuzuschneiden.				
	 TERRASSENBRETTER	1	120x28	14+1 L-2965
				9 L-3055- 4055

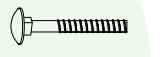
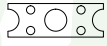
Teileliste 3

Nina 28-B mit Terrasse

Pos			Stck	Profil (mm)	Länge (mm)
	FUSSBODENLEISTE		✓	18x40	11,0 lfm
A28-1	ADAPTER 120x66	Obere seite 	✓	120x66	2110
BL-1	DACHBLENDEN 350mm		4	18x350	3218
BL-2	DACHBLENDEN 350mm		2	18x350	3400
BS-1	DACHBLENDEN- Blendenstützen 44x65		8	44x65	300
UPB-1	DACHBLENDEN- U-Profil für Blenden		✓	65x44	20,0 lfm
VL-1	DACHBLENDEN- Verbindungsleisten 350mm		2	120x18	350
DPL-1	DACHPAPPENLEISTE 15x28		✓	15x28	13,0 lfm
T4-1	TRAUFENLEISTE 40x18		✓	40x18	13,0 lfm
SP2-1	STÜTZPFOSTEN 90x90	! 	✓	90x90	1995
SP2-2	STÜTZPFOSTEN 90x90	! 	✓	90x90	1995
SM-1	Sturmleisten		2	40x18	2085
SM-2	Sturmleisten		2	40x18	2200
DzT 40-1	ECKTÜR- Deckbrett zum Tür 40		1	18x40	1585
VK1-1	ECKTÜR- Verkleidungsleisten für Vordachelement	45° 	✓	58x12	1110
P7L-1	ECKTÜR- linke Türpfoste	40 	1	67x77	2015
P7R-1	ECKTÜR- rechte Türpfoste	40 	1	67x77	2015
VE1	ECKTÜR- Vordachelement 1435x745		1		
SH	Schlaghölzer		3		
SS01	Schlossschrauben M8x60 Mutter U-Scheibe		12	M8	
VS	VERBINDUNGSTREIFEN für verbinden der Wandbohlen		2		
VP2	Verstellbare Pfostenstütze M16		2	M16	
NG3	DACHPAPPNÄGEL 2.0x18		510		
NG1	NÄGEL 2.5x50	Dachbretter Fußbodenbretter		756	
NG2	NÄGEL 2.5x60	Terrassenbretter		299	

Teileliste 4

Nina 28-B mit Terrasse

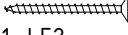
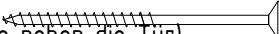
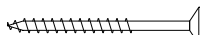
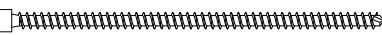
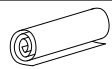
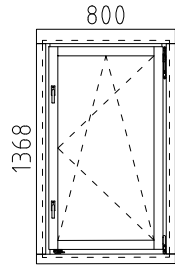
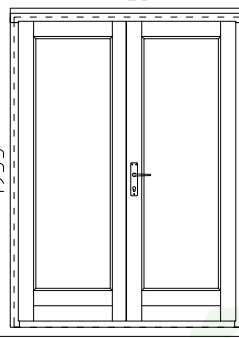
Pos		Stck	Profil (mm)	Länge (mm)
SR01	SCHRAUBEN 3.0x30 Dachpappenleisten, Fussbodenleisten Traufenleisten 40x18, Verbindungsleisten VL-1 	82		
SR03	SCHRAUBEN 3.5x45 U-Profil, Verbindungstreifen VS, Deckbrett DzT40-1, Vordachelement VE1, LE1, LE2 Verkleidungsleisten VK-1, HL1 	150		
SR11	SCHRAUBEN 5.0x100 Fundamenthölzer pos 017 und 020 (1. Bohlenreihe neben die Tür) 	68		
SR10	SCHRAUBEN 5.0x70 Blendenbefestigung Blendestützen 	70		
SR21	SCHRAUBEN 6.0x140 (ASSY für Dachbalken) 	4		
	DACHPAPPE 	✓	7,1m-4st.	29,0 lfm
	FENSTER 800x1368	2		
	<div style="display: flex; align-items: center;">  <div style="margin-left: 20px;"> <p>A42-14</p> <p>DIN 1xrechts/1xlinks</p> </div> </div>			
	TÜR 1425x1955	1		
	<div style="display: flex; align-items: center;">  <div style="margin-left: 20px;"> <p>TU4-GH</p> <p>DIN rechts</p> </div> </div>			
	✓ - bitte selber anpassen (falls nötig)!			

Fußbodenbretter / Terrassenbretter Nina 28-B mit Terrasse

Fußbodenbretter 113x18

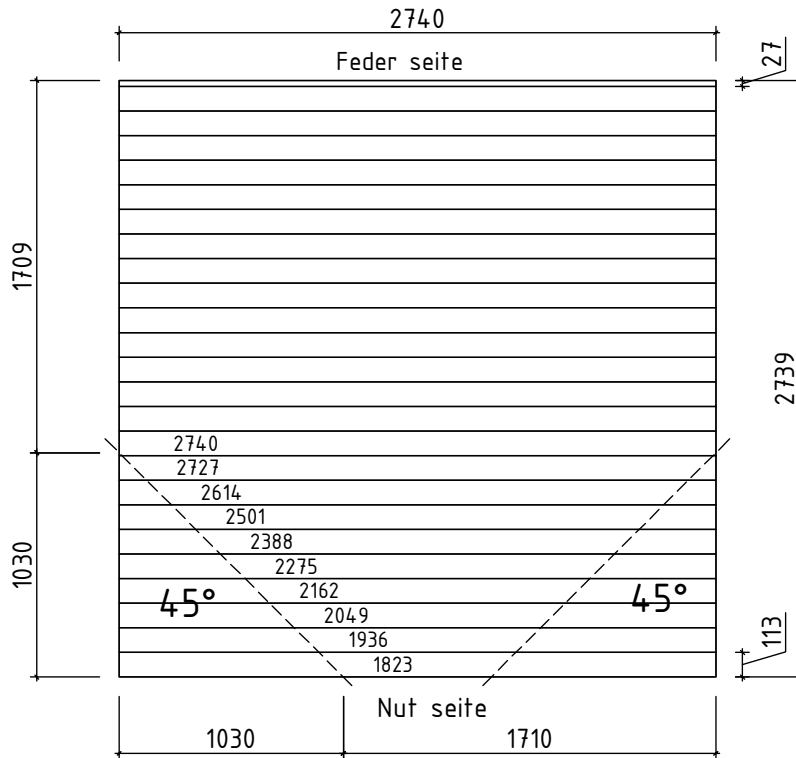

Terrassenbretter 120x28

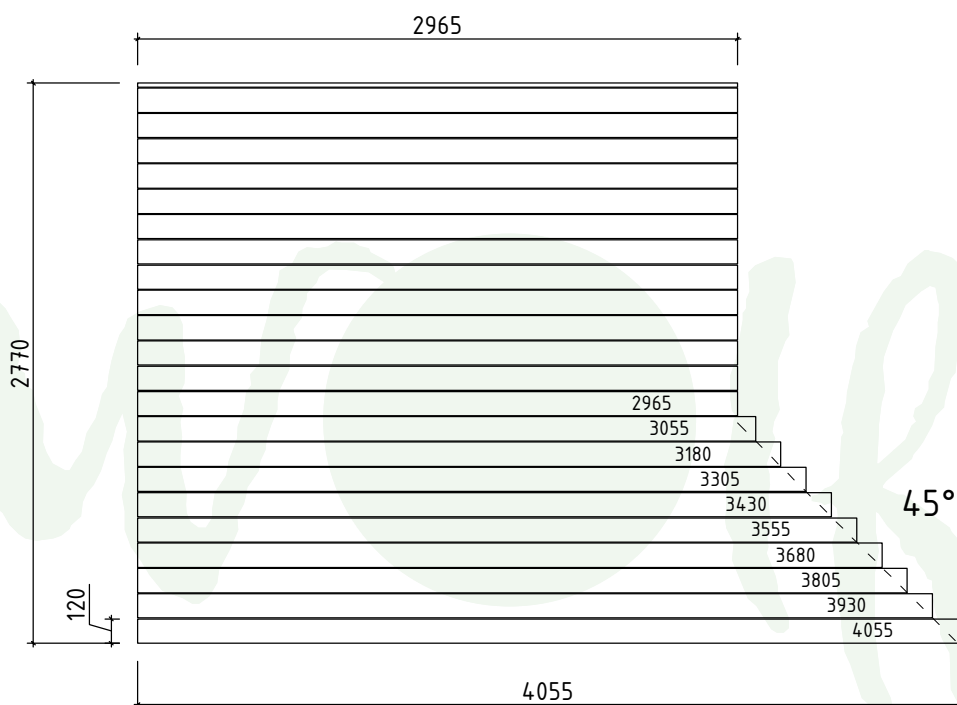

Wandplan 1 und 2

Nina 28-B mit Terrasse

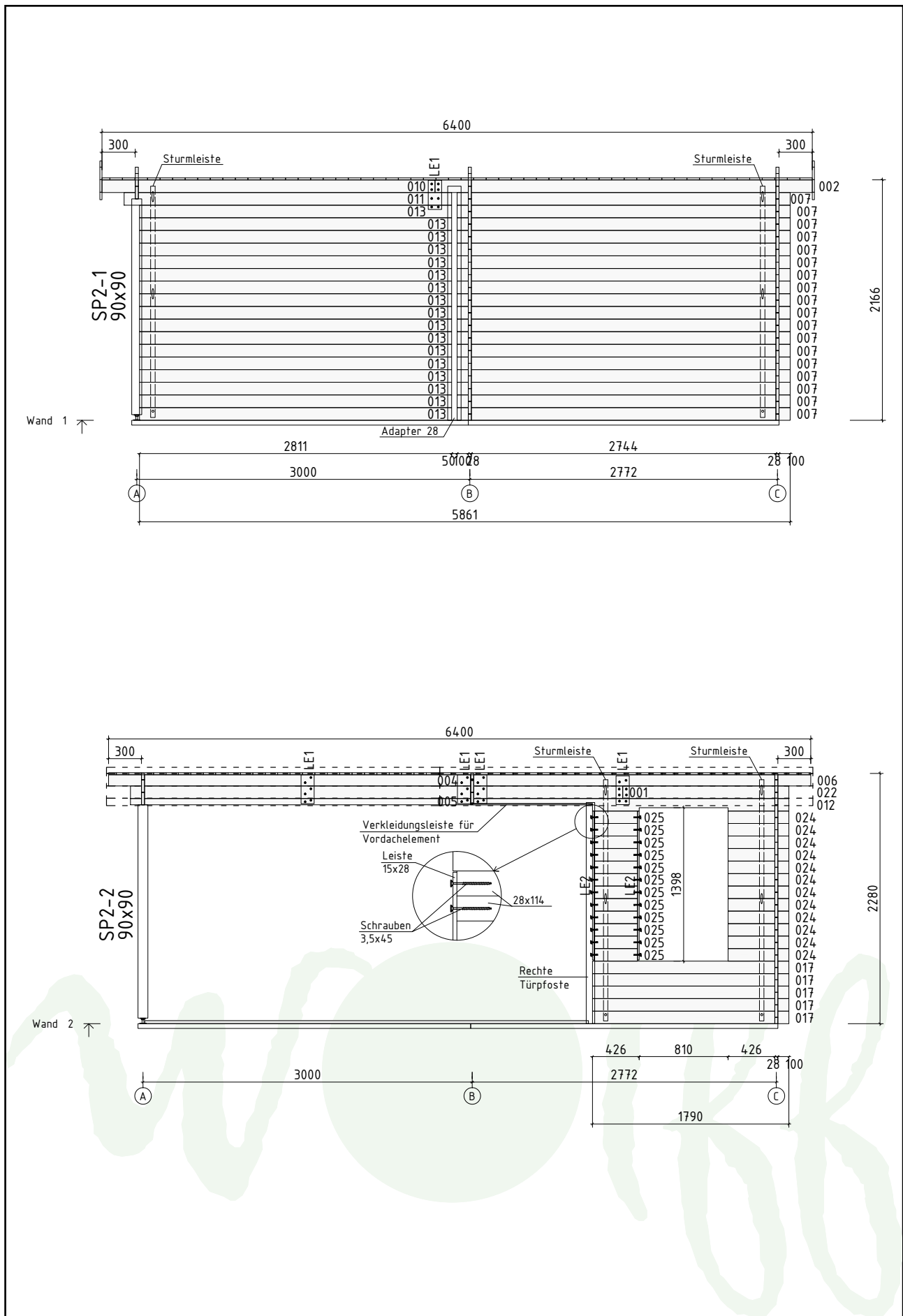

Wandplan A Nina 28-B mit Terrasse

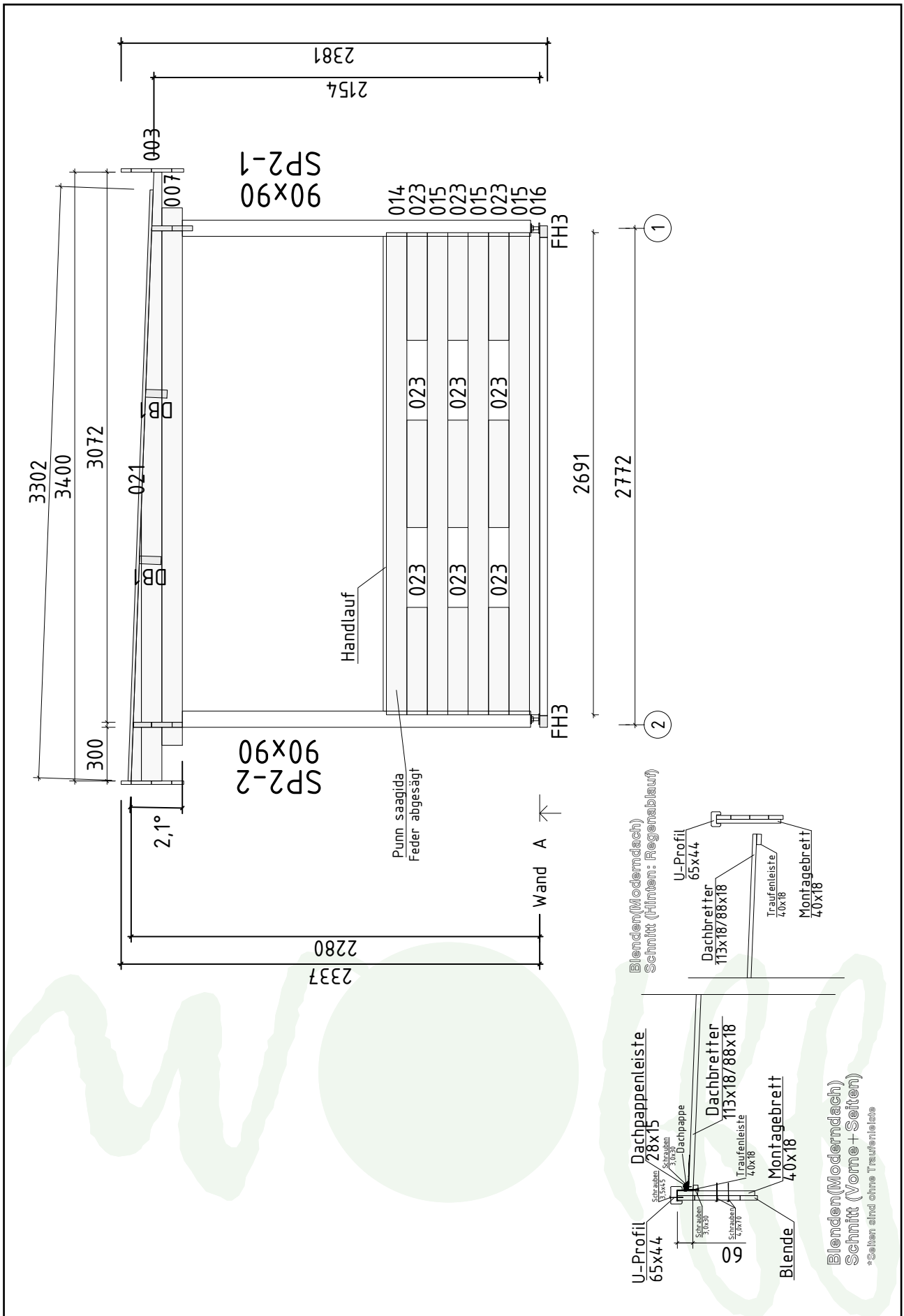

Wandplan B und C

Nina 28-B mit Terrasse

