

# Julia 28-B

Wandaußenmaß: 280 x 280 cm

Bohlenstärke: 28 mm



**Dieses Haus lässt sich auch spiegelverkehrt aufbauen.  
Darum ist es erforderlich, die Fußbodenbretter im Eingangsbereich  
laut beigefügter Zeichnung selbst zuzuschneiden.**

Kontrolliert durch:

Achtung: Alle angegebenen Maße sind ca.-Maße!

# 3D-Darstellung Julia 28-B

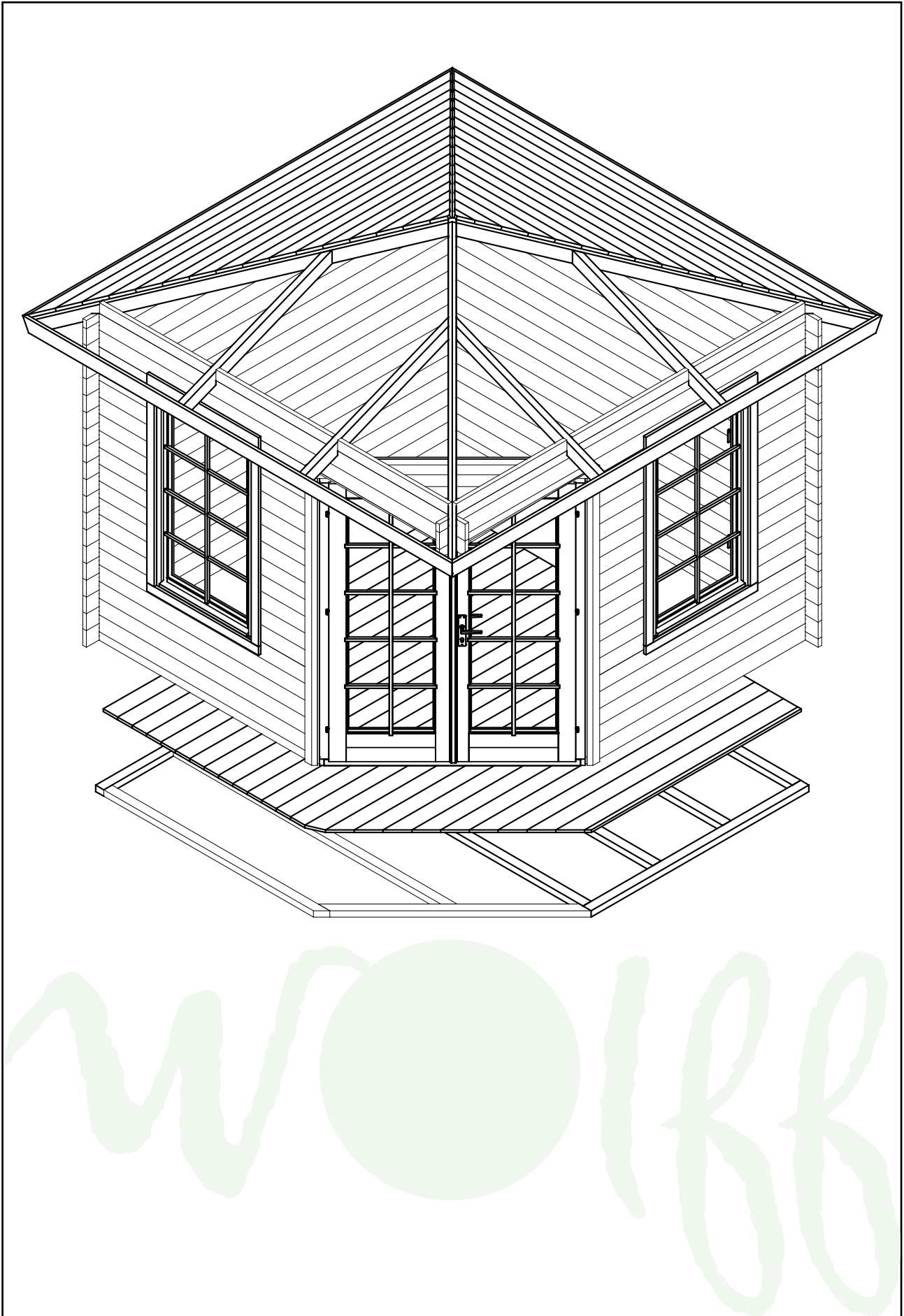

# Grundriss und Dachplan Julia 28-B

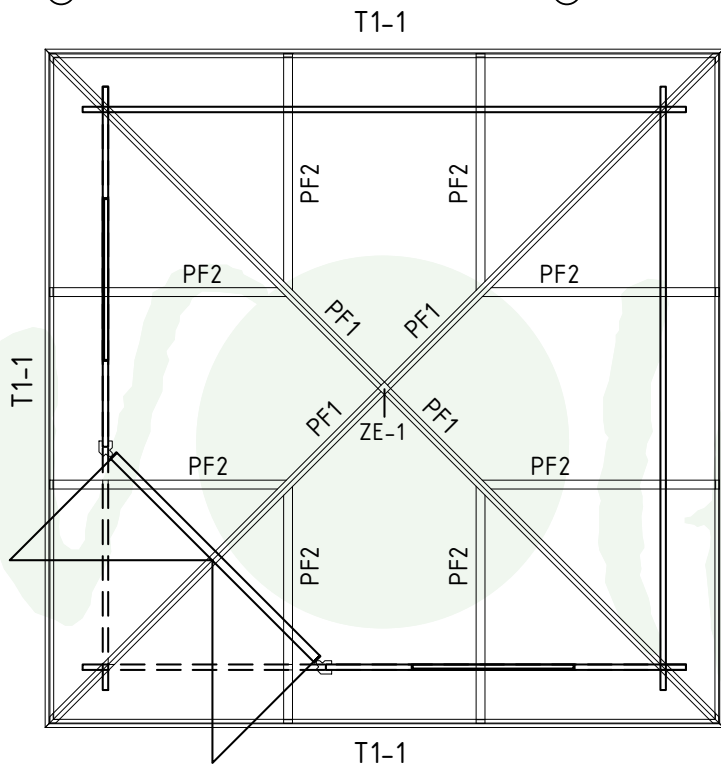
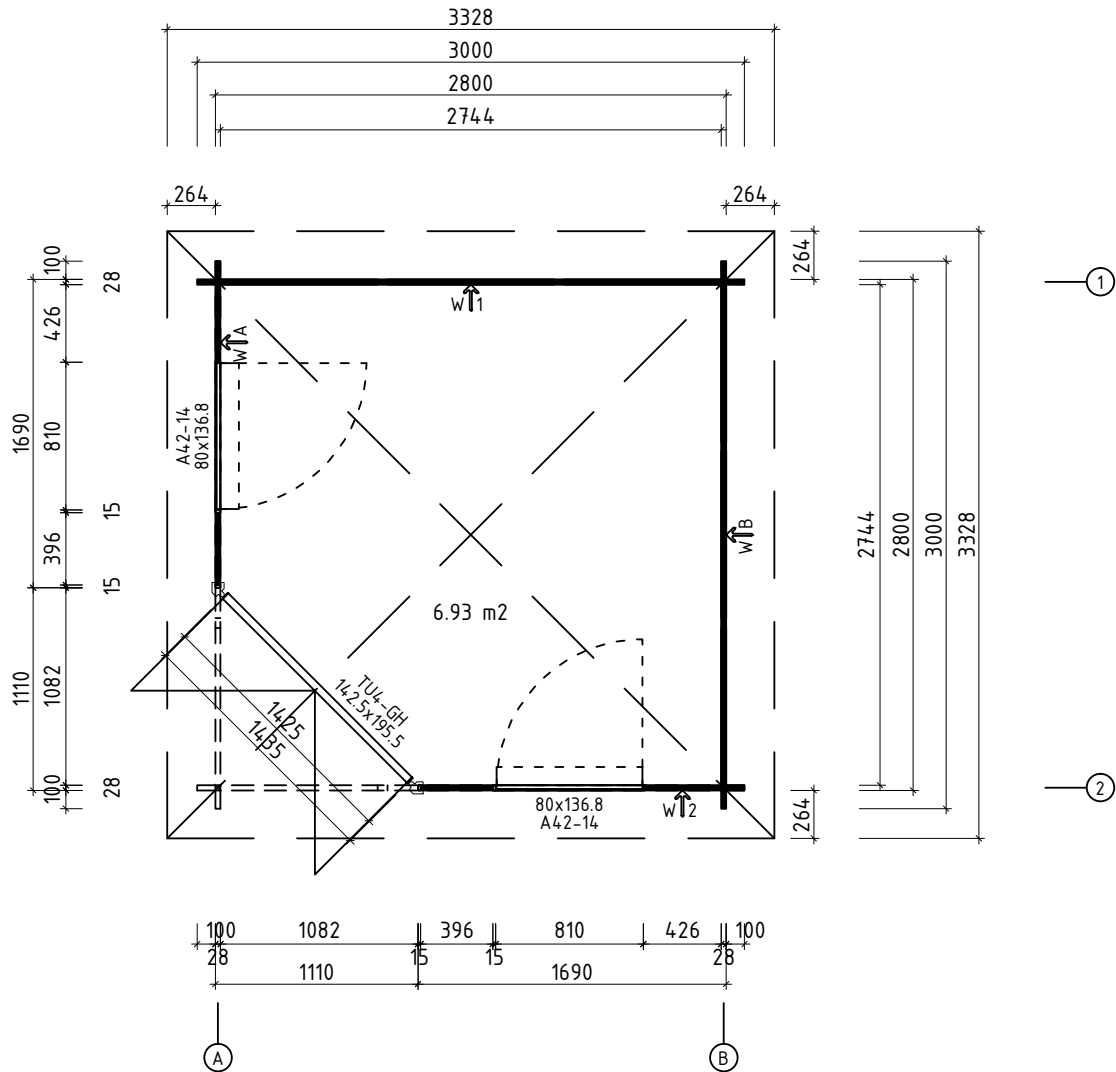





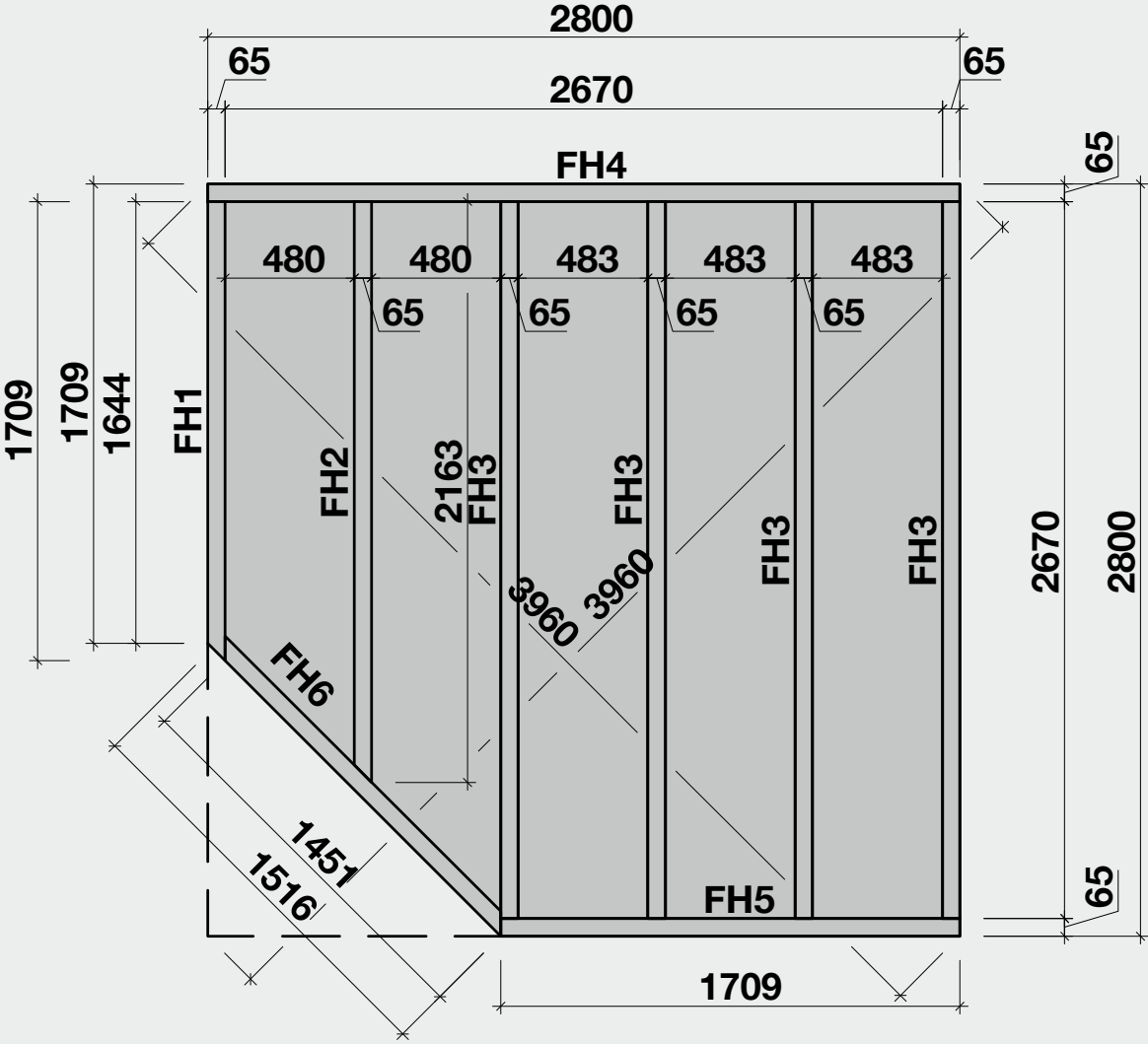





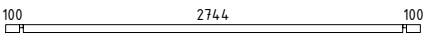
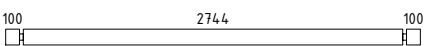
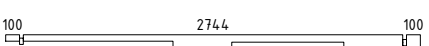
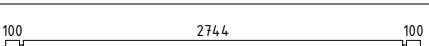
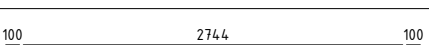
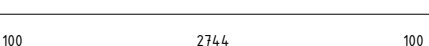
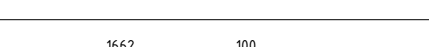
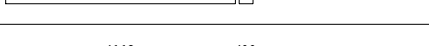

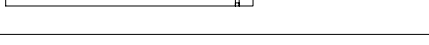

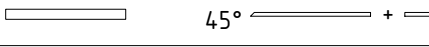

# Lagerholzplan und Fundamentplan Julia 28-B

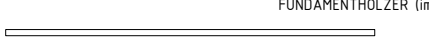
Wir empfehlen als Fundament für Ihr Gartenhaus eine vollflächig festgegründete, gepflasterte oder betonierte Fläche.  
Wahlweise ist auch ein Punkt- oder Streifenfundament möglich.

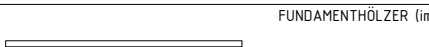





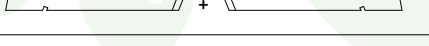
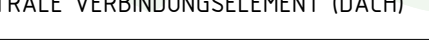





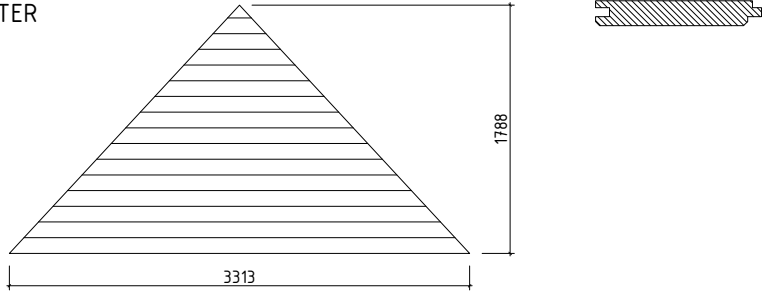



# Teileliste 1

## Julia 28-B

| Pos   |   | Stck | Profil (mm) | Länge (mm) |
|-------|---|------|-------------|------------|
| 001   |    | 2    | 28x57       | 3000       |
| 002   |    | 38   | 28x114      | 3000       |
| 003   |    | 1    | 28x114      | 3000       |
| 004   |    | 2    | 28x114      | 3000       |
| 005   |    | 1    | 28x57       | 3000       |
| 006   |    | 1    | 28x114      | 3000       |
| 007   |    | 9    | 28x114      | 1790       |
| 008   |    | 1    | 28x114      | 1790       |
| 009   |    | 1    | 28x57       | 1790       |
| 010   |    | 4    | 28x73       | 912        |
| 011   |                                        | 4+4  | 28x73       | 869        |
| 012   |                                        | 24   | 28x114      | 554        |
| 013   |                                        | 24   | 28x114      | 396        |
| FH4   | FUNDAMENTHÖLZER (imprägniert)<br>      | 1    | 65x44       | 2800       |
| FH3   | FUNDAMENTHÖLZER (imprägniert)<br>      | 4    | 65x44       | 2670       |
| FH2   | FUNDAMENTHÖLZER (imprägniert)<br>      | 1    | 65x44       | 2163       |
| FH5   | FUNDAMENTHÖLZER (imprägniert)<br>      | 1    | 65x44       | 1709       |
| FH1   | FUNDAMENTHÖLZER (imprägniert)<br>      | 1    | 65x44       | 1709       |
| FH6   | FUNDAMENTHÖLZER (imprägniert)<br>      | 1    | 65x44       | 1516       |
| LE1   | LEISTE<br>                             | 4    | 15x28       | 1358       |
| PF1   | PFETTEN<br>                            | 4    | 44x94       | 2425       |
| PF2   | PFETTEN<br>                            | 4+4  | 44x85       | 1286       |
| ZE-1  | ZENTRALE VERBINDUNGSELEMENT (DACH)<br> | 1    | 44x44       | 90         |
| P7L-1 | ECKTÜR- linke Türpfoste<br>            | 1    | 67x77       | 2015       |
| P7R-1 | ECKTÜR- rechte Türpfoste<br>           | 1    | 67x77       | 2015       |

# Teileliste 2

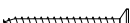
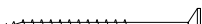
## Julia 28-B

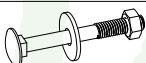
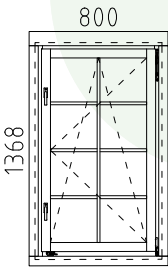
| Pos      |   | Stck | Profil (mm) | Länge (mm) |
|----------|---|------|-------------|------------|
|          | DACHBRETTER<br>   | 4    | 113x18      |            |
|          | FUSSBODENBRETTER<br>  | 25+1 | 113x18      | 2740       |
|          | FUSSBODENLEISTE<br>  |      | 18x40       | 11,0 lfdm  |
| DzT 40-1 | ECKTÜR- Deckbrett zum Tür 40<br>   | 1    | 18x40       | 1585       |
| VK1-1    | ECKTÜR- Verkleidungsleisten für Vordachelement<br>   | 2    | 58x12       | 1110       |
| VE1      | ECKTÜR- Vordachelement 1435x745<br>   | 1    |             |            |
| T1-1     | TRAUFBRETTER 120X18<br>  | 4    | 120x18      | 3425       |
| SM-1     | Sturmleisten<br>  | 4    | 40x18       | 2110       |
| SH       | Schlaghölzer<br>   | 3    |             |            |
| NG1      | NÄGEL 2.5x50<br>Dachbretter<br>Fussbodenbretter<br>  | 812  |             |            |
| SR01     | SCHRAUBEN 3.0x30<br>Fussbodenleiste<br>  | 22   |             |            |
| SR03     | SCHRAUBEN 3.5x45<br>Traufbretter, LE1, Deckbrett<br>Verkleidungsleiste, Vordachelement<br>                 | 94   |             |            |
| SR10     | SCHRAUBEN 5.0x70<br>Pfetten 85x44<br>pos 007 und 009 (1. Bohlenreihe neben die Tür)<br>                     | 12   |             |            |
| SR11     | SCHRAUBEN 5.0x100<br>Fundamenthölzer<br>pos 001, 003, 010 und 011; Pfetten 94x44, 85x44<br>                 | 76   |             |            |
| SS01     | Schlossschrauben M8x60 Mutter U-Scheibe<br>Sturmleisten<br>  | 12   |             |            |
|          | FENSTER 800x1368<br><br>A42-14<br>DIN 1xrechts; 1xlinks  | 2    | A42-14      |            |

# Teileliste 3

## Julia 28-B

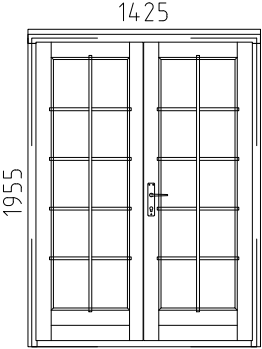
| Pos |   | Stck | Profil<br>(mm) | Länge<br>(mm) |
|-----|---|------|----------------|---------------|
|     | <p style="text-align: center;">TÜR 1425x1955</p> <div style="display: flex; align-items: center;">  <div style="margin-left: 20px;"> <p>TU4-GH</p> <p>DIN rechts</p> </div> </div> | 1    | TU4-GH         |               |
|     |   |      |                |               |
|     |   |      |                |               |
|     |   |      |                |               |
|     |   |      |                |               |
|     |   |      |                |               |
|     |   |      |                |               |
|     |   |      |                |               |
|     |   |      |                |               |
|     |   |      |                |               |
|     |   |      |                |               |
|     |   |      |                |               |
|     |   |      |                |               |
|     |   |      |                |               |
|     |   |      |                |               |
|     |   |      |                |               |
|     |   |      |                |               |
|     |   |      |                |               |
|     |   |      |                |               |
|     |   |      |                |               |
|     |   |      |                |               |
|     |   |      |                |               |
| ✓   | - bitte selber anpassen (falls nötig)!  |      |                |               |

# Zuschneiden der Fußbodenbretter Julia 28-B

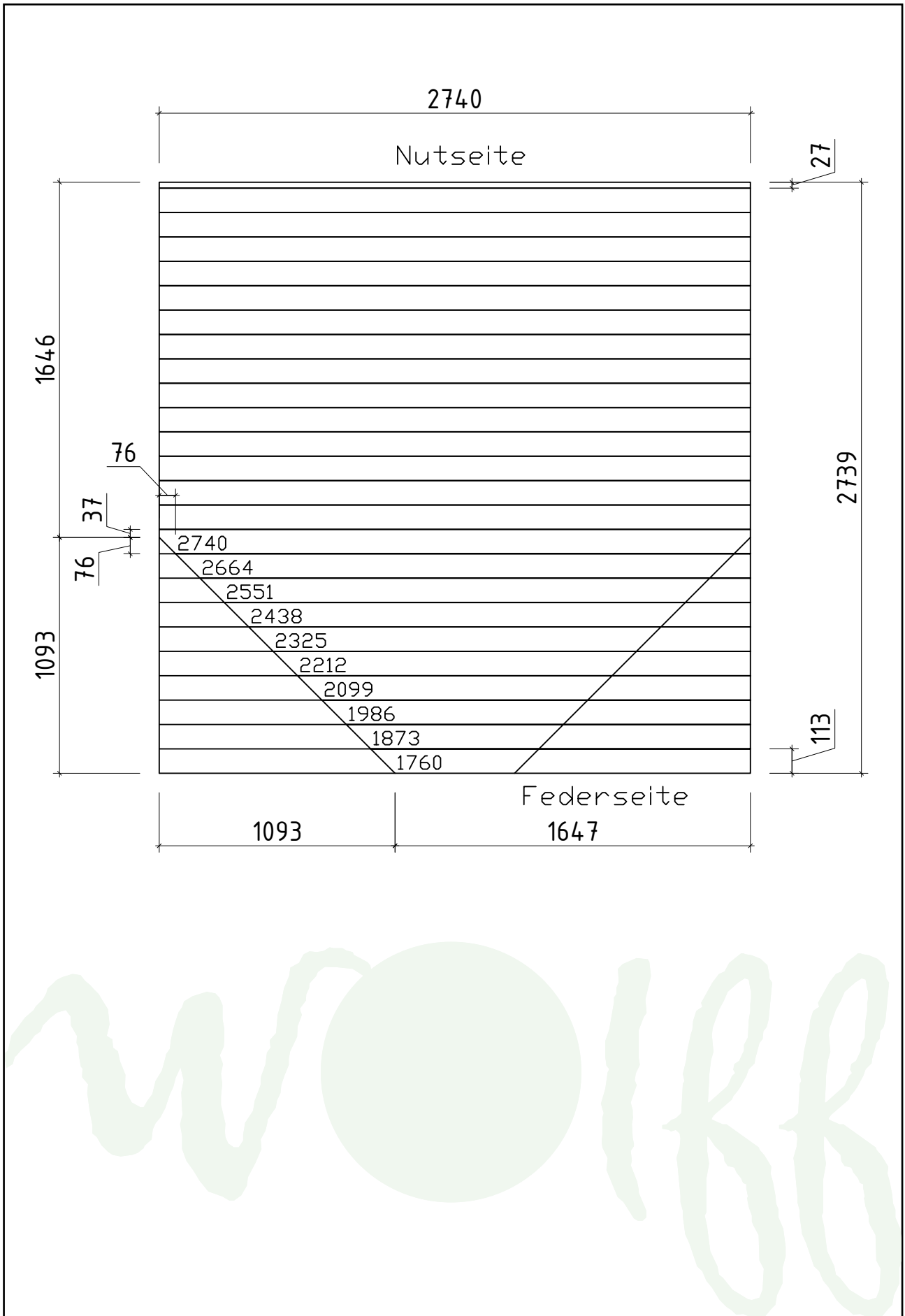



# Vordachelement Julia 28-B

Step 1: Dachelement an den Wänden verschrauben.

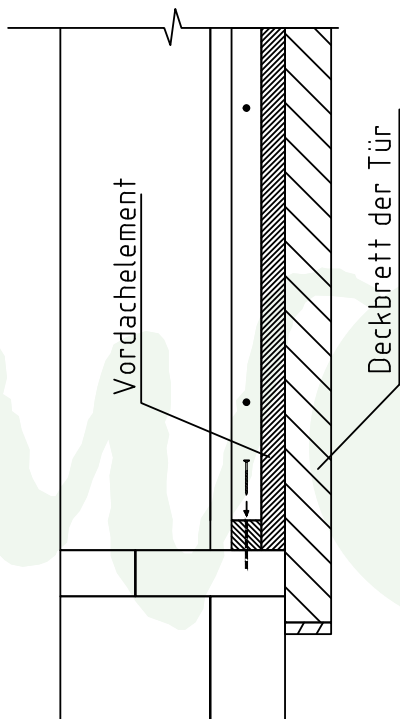

Step 2: Das Deckbrett muss von oben (durch das VD-Element) an das Dachelement verschraubt werden.

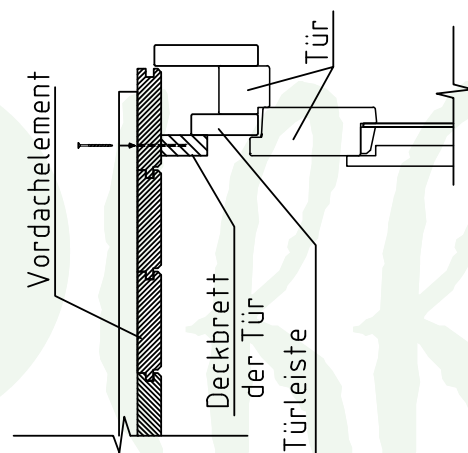

Step 3: Die Verkleidungsleisten in die richtige Länge schneiden und unter das VD-Element befestigen.

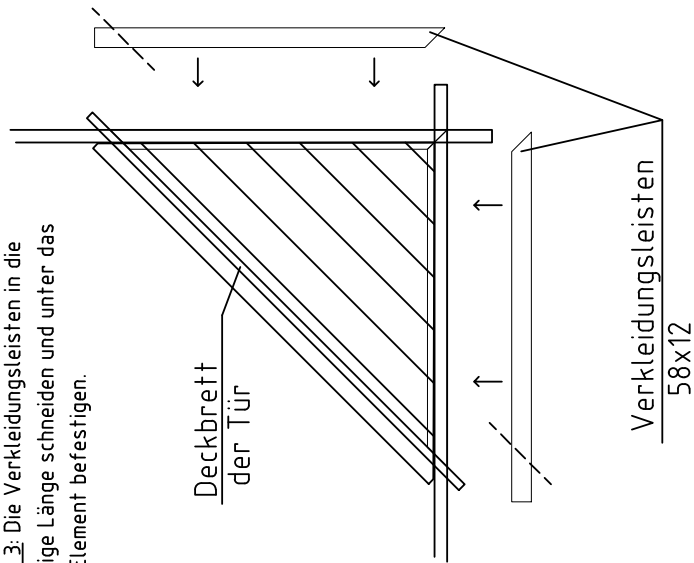

# Wandplan 1 Julia 28-B

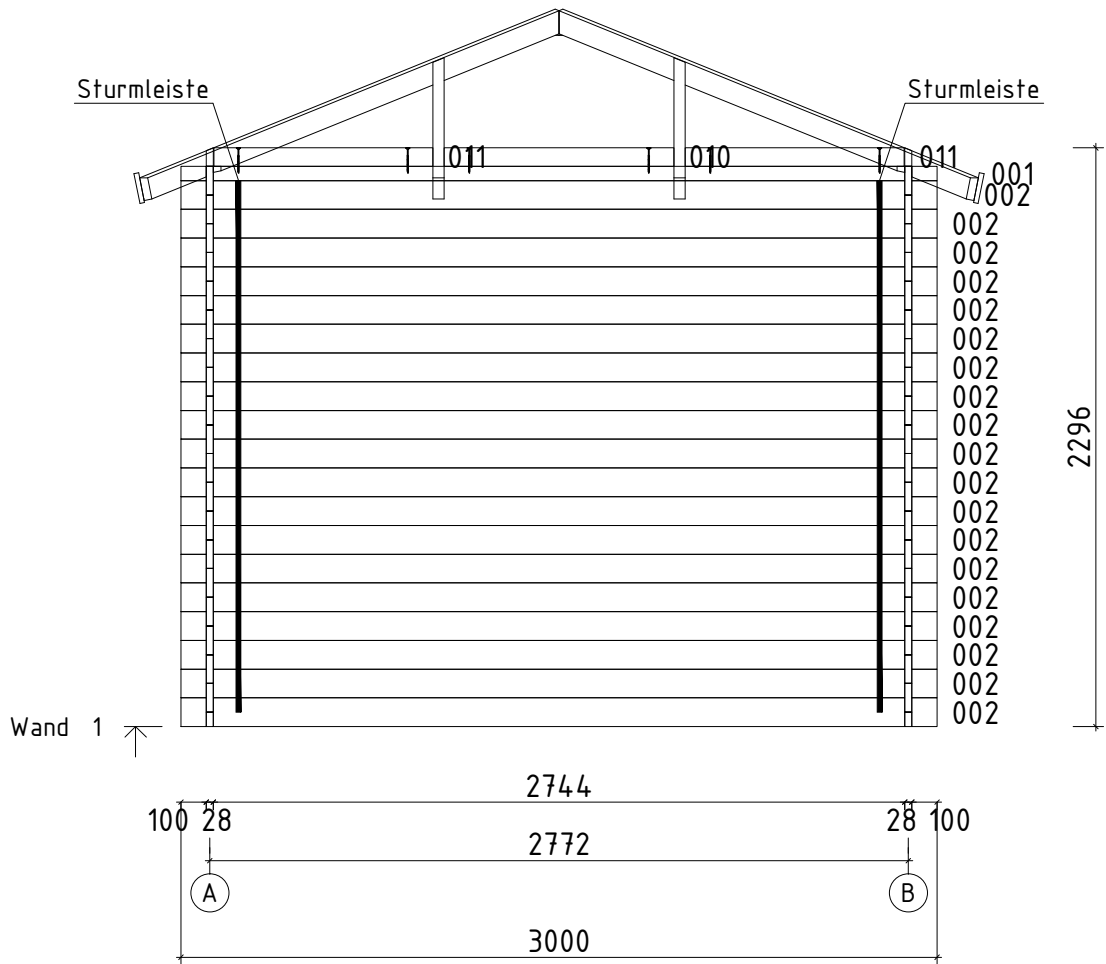

# Wandplan 2 Julia 28-B

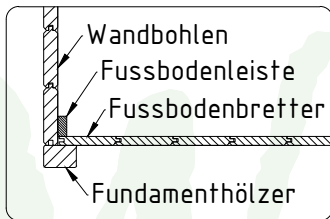
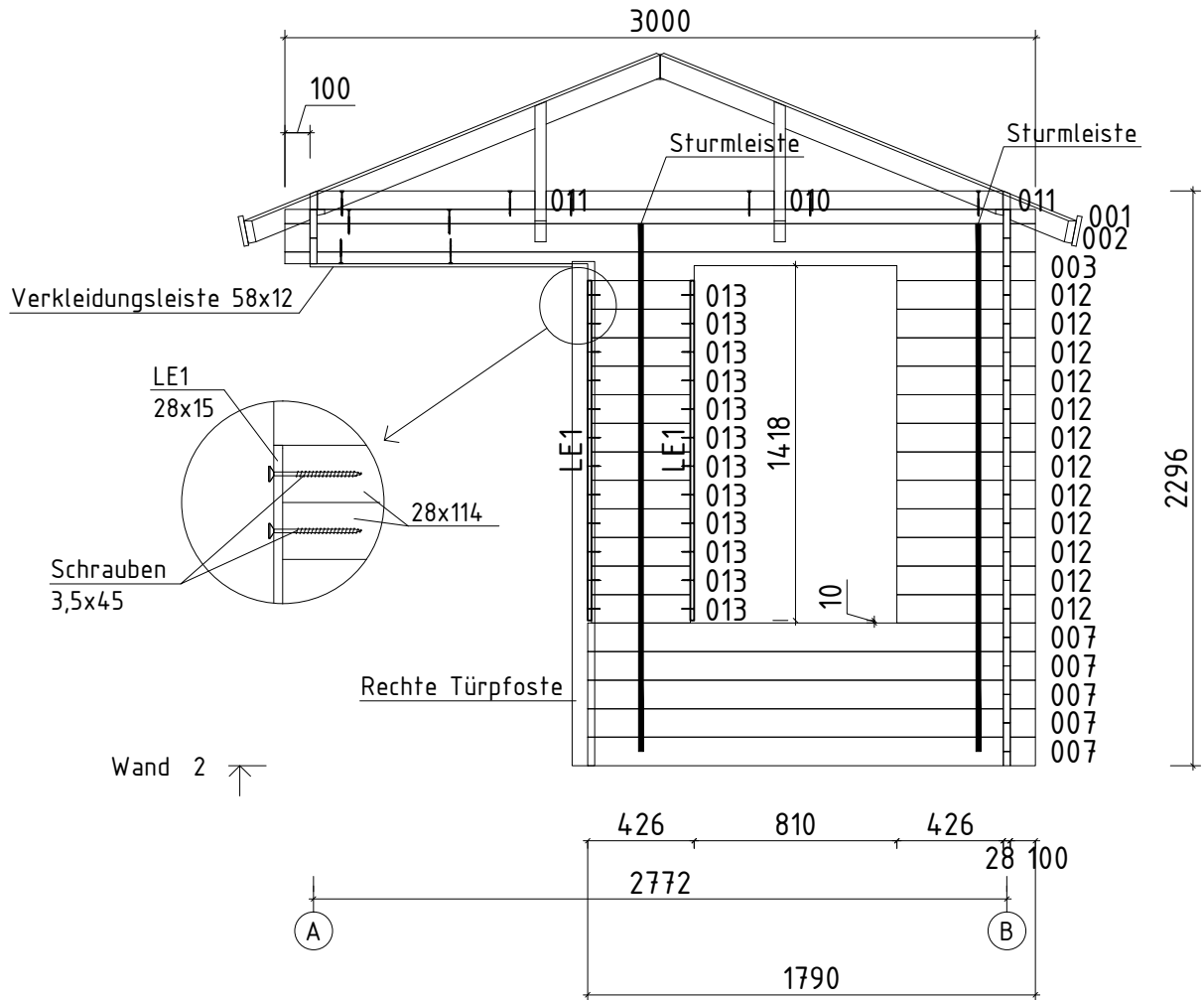

# Wandplan A

## Julia 28-B

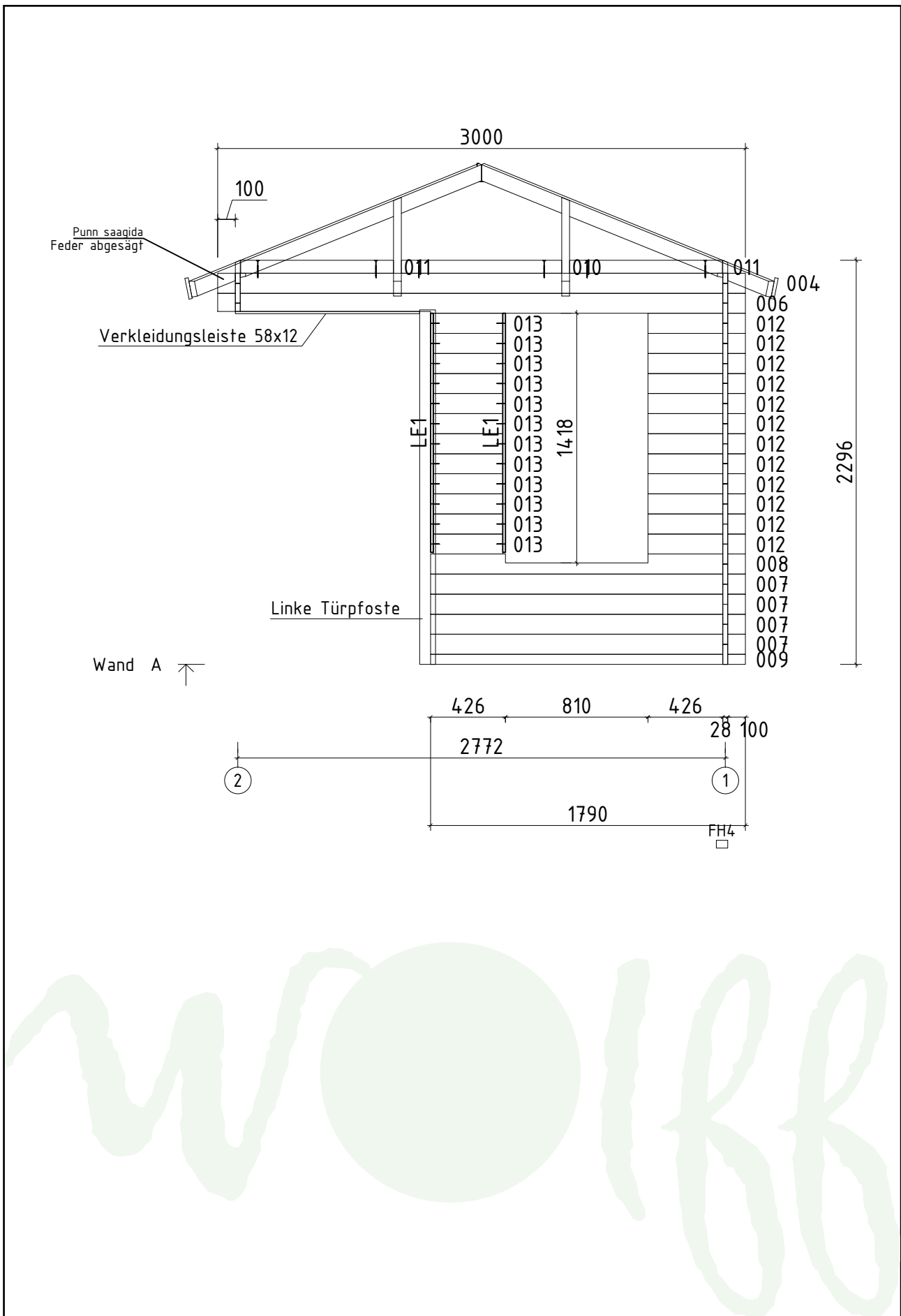

# Wandplan B Julia 28-B

