

# Toulouse

Wandaußenmaß: 380 x 250 cm

Bohlenstärke: 28 mm



Kontrolliert durch:





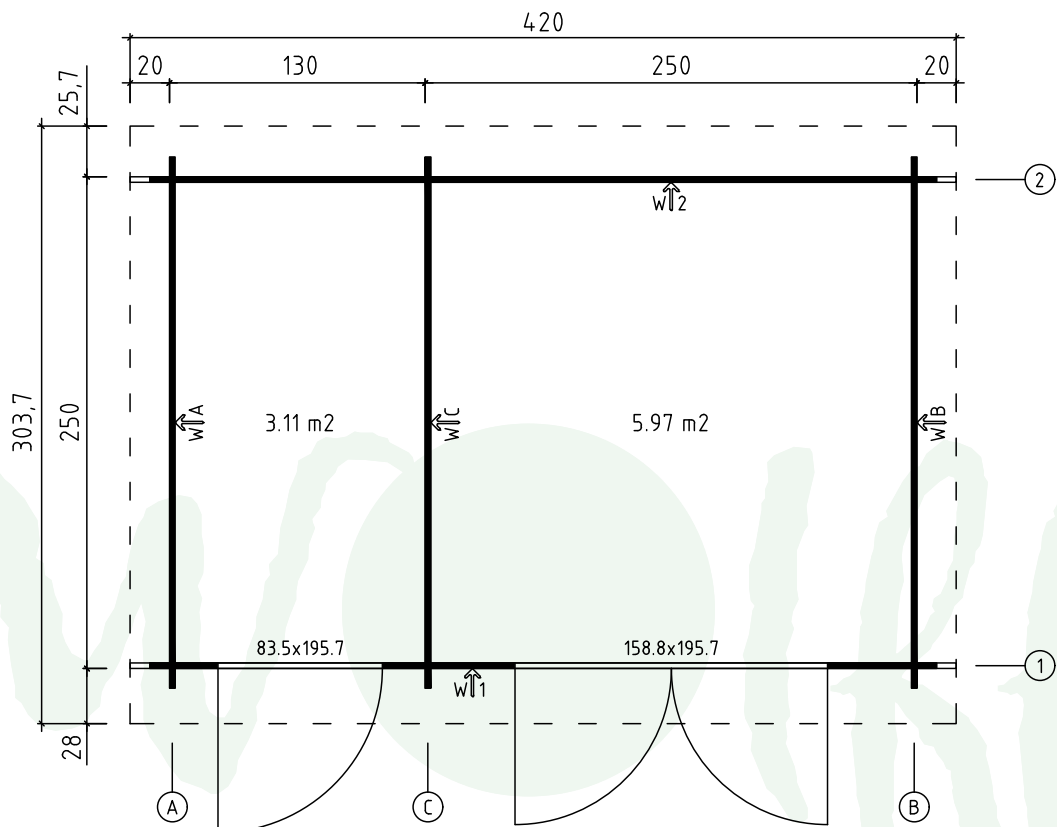
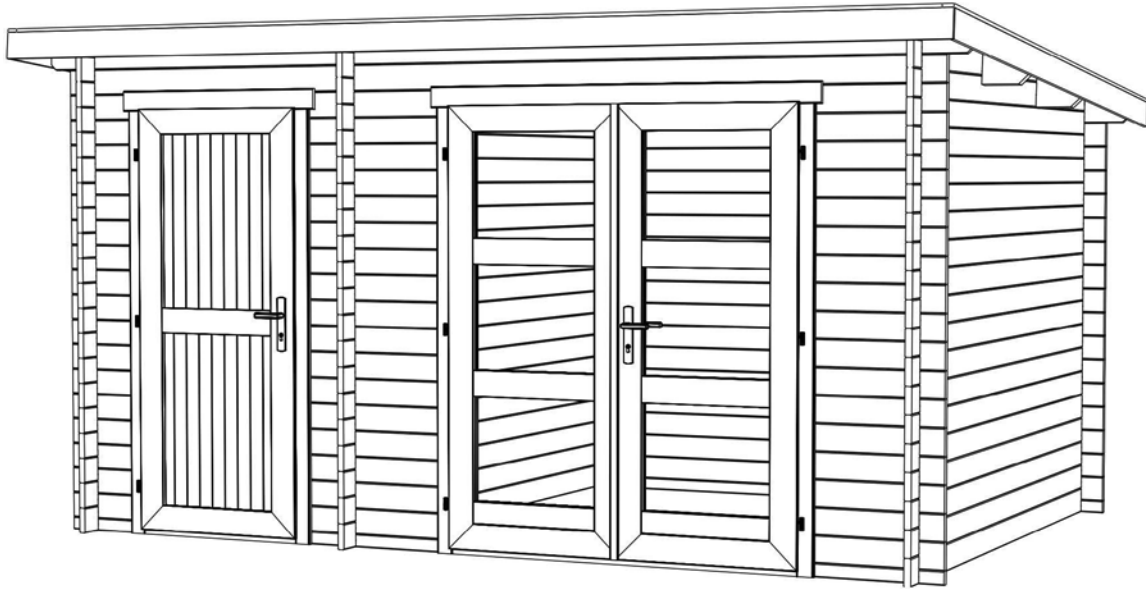







Achtung: Alle angegebenen Maße sind ca.-Maße!

# 3D-Ansicht und Grundriss Toulouse

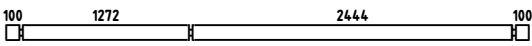
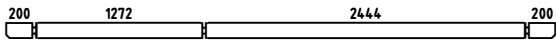
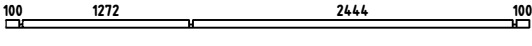
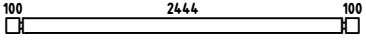
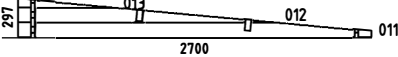
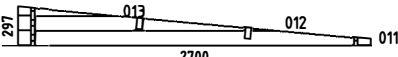
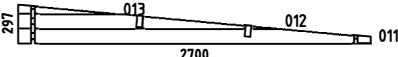
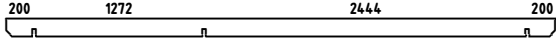



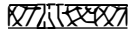

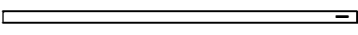
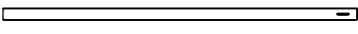
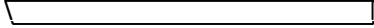

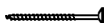
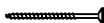

# Teileliste 1

## Toulouse

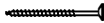
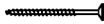
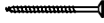
| Pos   |  | Q  | P<br>(mm) | L<br>(mm) |
|-------|--|----|-----------|-----------|
| 001   |   | 1  | 28x57     | 342       |
| 002   |   | 1  | 28x57     | 665       |
| 003   |   | 1  | 28x57     | 550       |
| 004   |   | 17 | 28x114    | 342       |
| 005   |   | 17 | 28x114    | 665       |
| 006   |   | 17 | 28x114    | 550       |
| 007   |   | 17 | 28x114    | 4000      |
| 008   |   | 2  | 28x114    | 4200      |
| 009   |   | 1  | 28x57     | 4000      |
| 010   |   | 51 | 28x114    | 2700      |
| WA-1  |   | 1  |           |           |
| WB-1  |   | 1  |           |           |
| WC-1  |   | 1  |           |           |
| A-PR1 | Roof beam - Dachbalken - Panne de toit - Perlina del tetto - Gordingen / dakbalk - Abipärtinid<br>  | 2  | 44x140    | 4200      |
|       | Roof boards - Dachbretter - Voliges - Perlina per tetto - Dakhout - Katuselaud<br>   | 47 | 90x15     | 3050      |
|       | Roofing felt fillet - Dachpappenteiste - Baguette de fixation du feutre bitumeux - Asse per fissaggio guaina bituminosa - Afdeklijst asfaltpapier - Katusepapiliist<br> | 2  | 15x45     | 3115      |
|       | Roofing felt fillet - Dachpappenteiste - Baguette de fixation du feutre bitumeux - Asse per fissaggio guaina bituminosa - Afdeklijst asfaltpapier - Katusepapiliist<br> | 1  | 15x45     | 4140      |
| TB-1  | Fascia board - Traufbrett - Bandeau de toit - Finitura lati tetto - Gevellijst - Räästalaud<br>   | 1  | 15x120    | 4230      |
| DRV-1 | Roof edge reinforcement - Dachrandverstärkung - Corniere de renfort de bord de toit - Rinforzo x tetto - Dakrand versterking - Räästatugevdus<br>                       | 1  | 15x45     | 4200      |
| DRV-1 | Roof edge reinforcement - Dachrandverstärkung - Corniere de renfort de bord de toit - Rinforzo x tetto - Dakrand versterking - Räästatugevdus<br>                       | 1  | 28x34     | 4230      |
| KFS-1 | Storm protection - Sturmleiste - Latte anti-tempete - Protezione anti vento - Stormverankering / beveiliging - Tormikinnitus<br>   | 2  | 22x45     | 2050      |
| KFS-2 | Storm protection - Sturmleiste - Latte anti-tempete - Protezione anti vento - Stormverankering / beveiliging - Tormikinnitus<br>   | 2  | 22x45     | 2500      |
|       | Gable moulding - Giebelleiste - Planche de rive - Finitura per frontale e retro del tetto - Gevellijst - Viilulaud<br>   | 2  | 15x120    | 3100      |



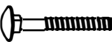



# Teileliste 2

## Toulouse

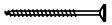
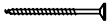
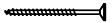
| Pos  |   | Q   | P<br>(mm) | L<br>(mm) |
|------|---|-----|-----------|-----------|
| HS9  | Screw for gable moulding - Schrauben für giebelleiste - Vis pour fixation planche de rive - Vite per fissare finiture davanti e dietro del tetto - Schroef voor gevellijst - Kruvi viilulauale                           | 16  | 3.5x50    |           |
| HS4  | Screw for roof edge reinforcement - Schrauben für Dachrandverstärkung - Vis pour fixation corniere renfort de bord de toit - Viti x rinforzo bordo tetto - Schroef voor dakrand versterking - Kruvi räästatugevdusele    | 10  | 3x30      |           |
| HS12 | Screw for fascia boards - Schrauben für Traufbretter - Vis pour fixation bandeau de toit - Viti x striscia del tetto - Schroef voor gevellijst - Kruvi räästalauale    | 10  | 4x40      |           |
| HS12 | Screw for roof edge reinforcement - Schrauben für Dachrandverstärkung - Vis pour fixation corniere renfort de bord de toit - Viti x rinforzo bordo tetto - Schroef voor dakrand versterking - Kruvi räästatugevdusele    | 10  | 4x40      |           |
| HS18 | Screw for roof beams - Schrauben für Dachbalken - Vis pour fixation pannes de toit - Viti per perline del tetto - Schroef voor gordingen / dakbalken - Kruvi pärlinitele   | 6   | 5x120     |           |
| HS18 | Screw for gable - Schrauben für Giebel - Vis pour fixation des pignons - Viti per timpano - Schroef voor gevelpunt - Kruvi viilude kinnitamiseks   | 6   | 5x120     |           |
| SH28 | Hammer block - Schlagholz - Calle de frappe - Blocco di legno da usare come cuscinetto quando si usa il martello - Slagklos - Löögi klots    | 1   |           |           |
| SFS  | Nut for storm protection - Schraubenmutter für Sturmleiste - Ecrou pour latte anti-tempete - Dado x asta protezione vento - Moer voor stormverankering - Mutter tormikinnitusele   | 8   | D6        |           |
| NF4  | Zn nail for roof - Zn Nägel für Dachbretter - Pointe pour fixation voliges de toit - Chiodi x perline tetto - Spijker(nagel) voor dakhout - Nael katuselauale    | 201 | 2x50      |           |
| NF5  | Zn nail for roofing felt fillet - Zn Nägel für Dachpappenteiste - Pointe pour baguette de fixation feutre bitumeux - Chiodi x carta bituminosa x tetto - Spijker(nagel) voor asfaltpapier afdeklijst - Papiilistunael  | 25  | 2x40      |           |
| BFS  | Bolt for storm protection - Bolzen für Sturmleiste - Boulon pour latte anti-tempete - Bullone x asta protezione vento - Bout voor stormankerlat - Puidupolt tormikinnitusele   | 8   | 6x60      |           |
| DFS  | Washer for storm protection - Dichtscheibe für Sturmleiste - Rondelle pour latte anti-tempete - Rondella x asta protezione vento - Afdichtring voor storm strip - Seib tormikinnitusele                                | 8   | D6        |           |
|      | Door - Tür - Porte - Porte - Deur - Uks TUK.3.030.SVP.MM SGC  | 1   |           |           |
|      | Door - Tür - Porte - Porte - Deur - Uks UL.2.100.IVV.MM TC  | 1   |           |           |
|      |   |     |           |           |
|      |   |     |           |           |
|      |   |     |           |           |
|      |   |     |           |           |
|      |   |     |           |           |
|      |   |     |           |           |
|      |   |     |           |           |
|      |   |     |           |           |
|      |   |     |           |           |
|      |   |     |           |           |
|      |   |     |           |           |

# Teileliste 3

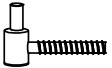
## Toulouse

| Pos  |  | Q | P<br>(mm) | L<br>(mm) |
|------|--|---|-----------|-----------|
| HS4  | Screw for door fillet - Schraube zur Befestigung Türleiste - Vis pour fixation baguette d'arrêt de porte - Viti per massellino della porta - Schroef voor deurlijst - Krugi ukse kokkuvaltšiliistule  | 5 | 3x30      |           |
| HS16 | Screw for door jamb - Schraube für Türrahmen - Vis de fixation partie haute avec montants du cadre de porte - Viti x fissaggio montanti porte - Schroef voor deurkozijn - Krugi ukse lengile          | 4 | 5x90      |           |
| HS25 | Screw for doorstep - Schrauben für swelle - Vis pour fixation barre de seuil - Vite per soglia della porta - Schroef voor deurdorpel - Krugi lävepakule   | 3 | 4.5x65    |           |
| TL4  | Door handle fittings - Türgriff - Poignée de porte - Maniglie - Deurhendel / klink - Ukse käepide VU   | 1 |           |           |
| TL5  | Set of door lock covers - Schlossblenden - Set de garnitures de porte - Copertura serrature - Slot sluitplaat set - Ukse lukuplaat    | 1 |           |           |
|      | Cylinder lock - Zylinderschloss - Barillet de porte - Serratura - Cylinder slot - Ukse lukusüdamik    | 1 | 30x35     |           |
|      | Male bolt hinge for door - Türband - Partie male de paumelle de porte - Cerniera anube x porta - Scharnier bout - Ukse polthing isane   | 6 |           |           |
|      | Striker for barrel bolt - Hülse für Grendelriegel - Gache au sol du targette - Boccola per fermo della porta - Huls voor vergrendelingsschuif - Vasturaud ukse servariivile                           | 2 |           |           |



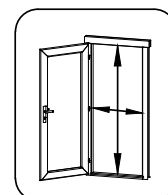
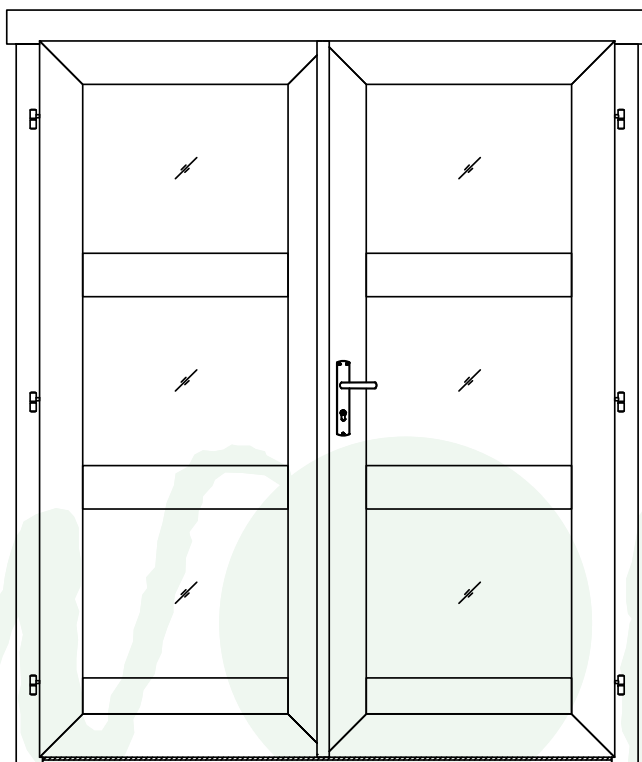

Door glass size - Glasgröße - Taille de la vitre:  
561x465

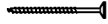

1488x1875

# Teileliste 4

## Toulouse

| Pos  |   | Q | P<br>(mm) | L<br>(mm) |
|------|---|---|-----------|-----------|
| HS25 | Screw for doorstep - Schrauben für swelle - Vis pour fixation barre de seuil - Vite per soglia della porta - Schroef voor deurdorpel - Krugi lävepakule  | 2 | 4.5x65    |           |
| TL4  | Door handle fittings - Türgriff - Poignee de porte - Maniglie - Deurhendel / klink - Ukse käepide VU    | 1 |           |           |
| TL5  | Set of door lock covers - Schlossblenden - Set de garnitures de porte - Copertura serrature - Slot sluitplaat set - Ukse lukuplaat                       | 1 |           |           |
|      | Cylinder lock - Zylinderschloss - Barillet de porte - Serratura - Cylinder slot - Ukse lukusüdamik   | 1 | 30x35     |           |

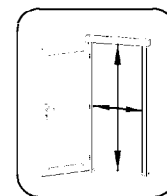
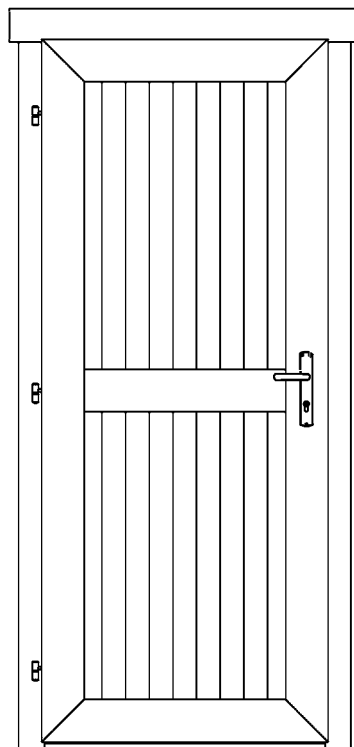

735x1875 mm

# Wandplan A, B und C Toulouse

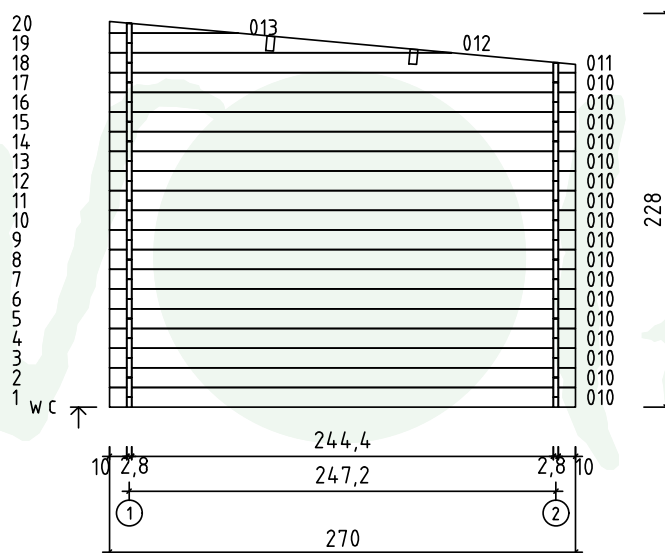
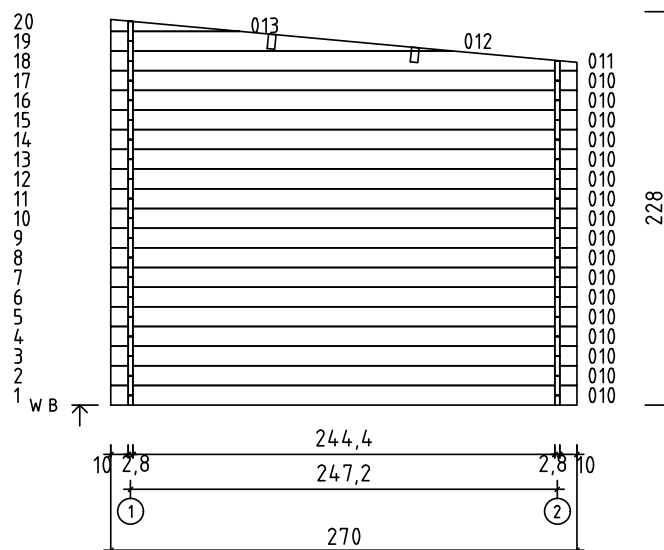
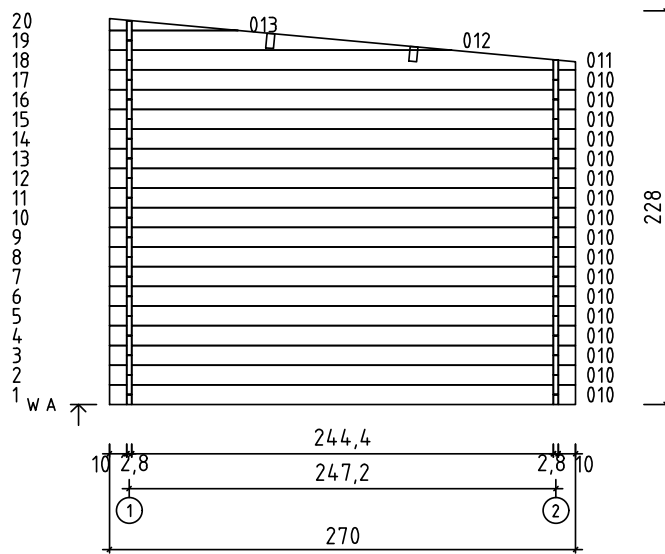

# Wandplan 1 und 2 Toulouse

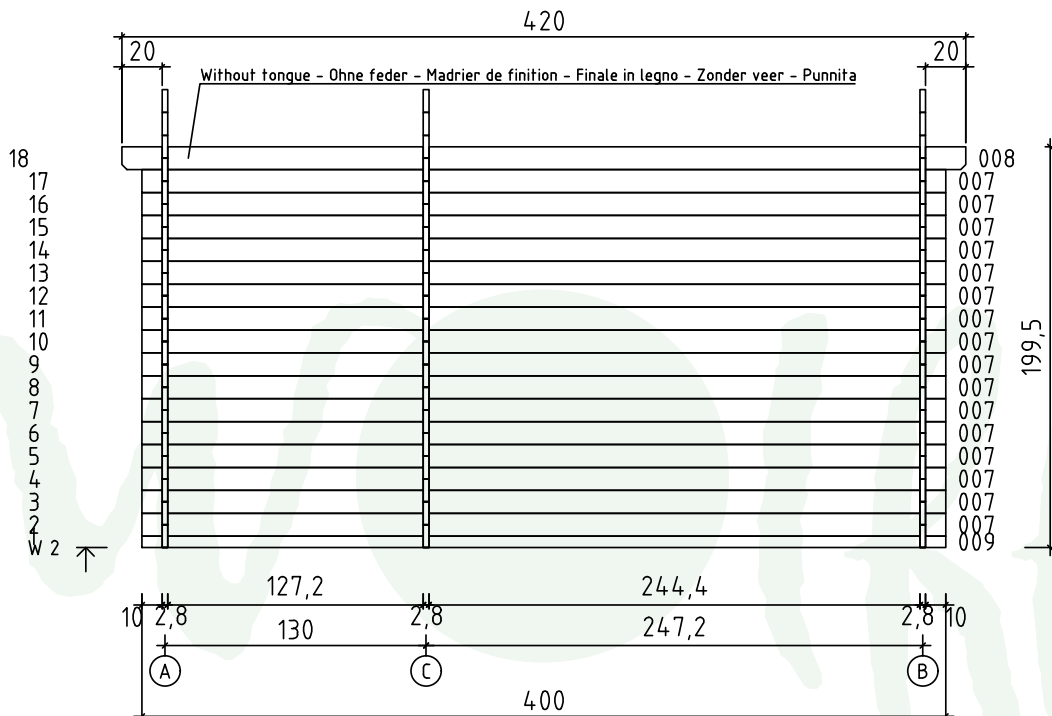
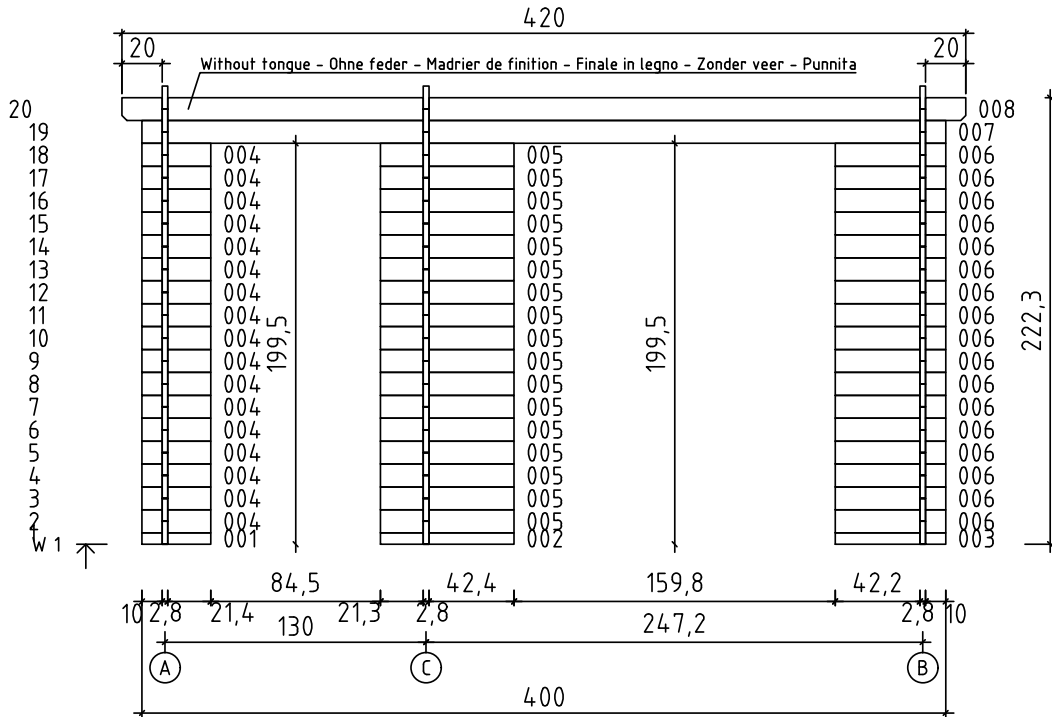



# Türdetails Toulouse

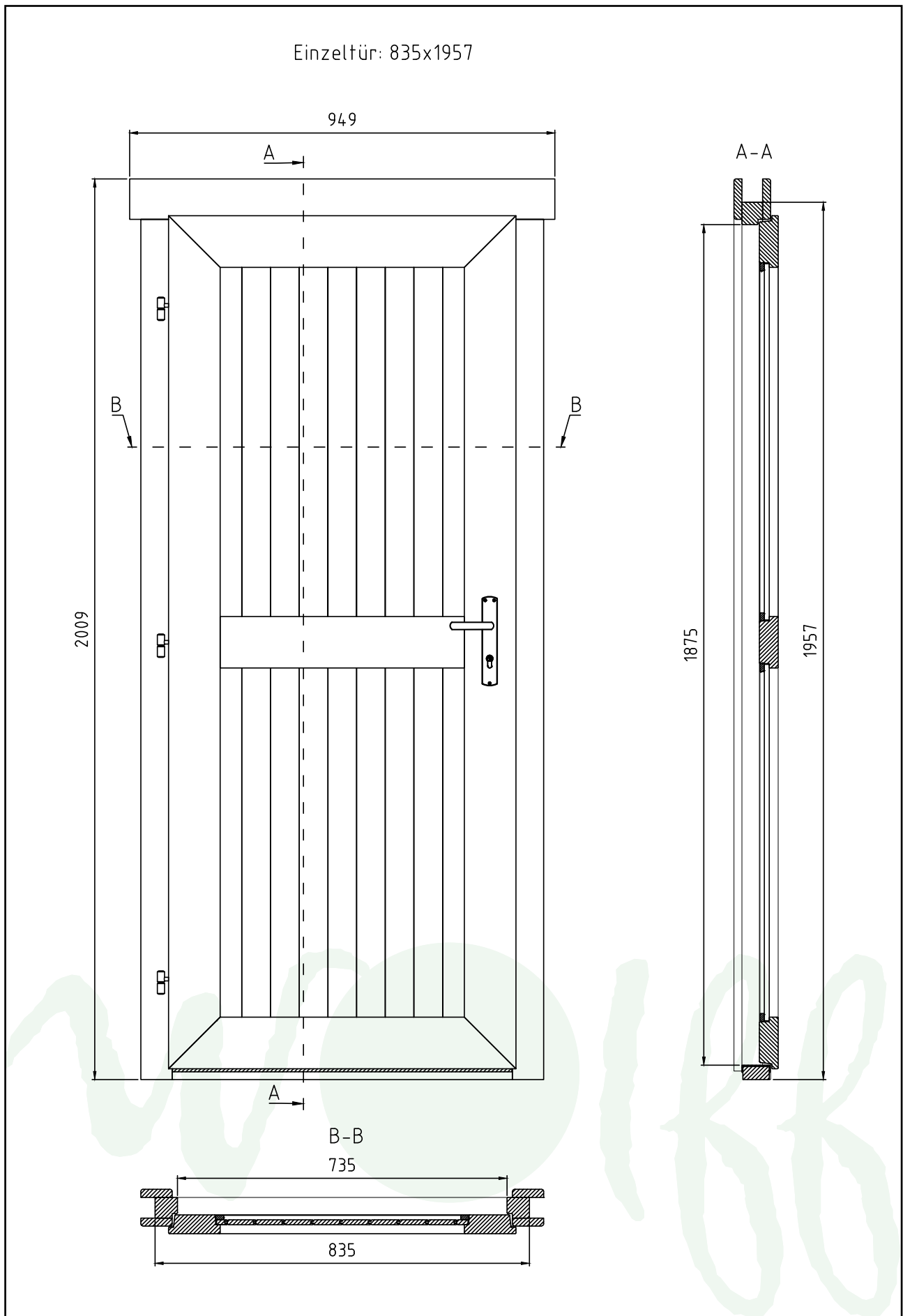

# Türdetails Toulouse

