

Emma 28-B

Wandaußenmaß: 200 x 260 cm

Bohlenstärke: 28 mm



Emma 28-A

Kontrolliert durch:

Achtung: Alle angegebenen Maße sind ca.-Maße!

3D-Darstellung und Grundriss Emma 28-B

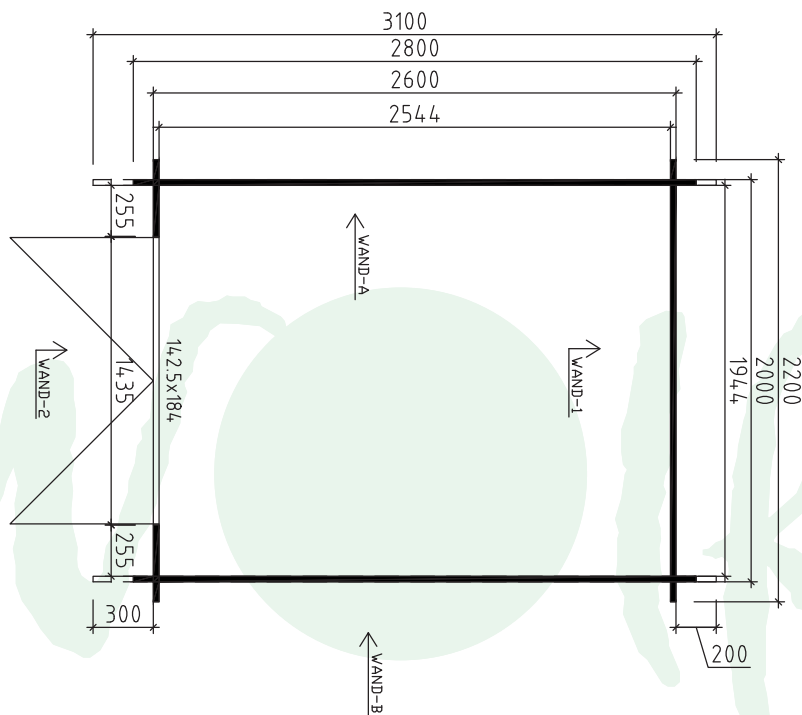
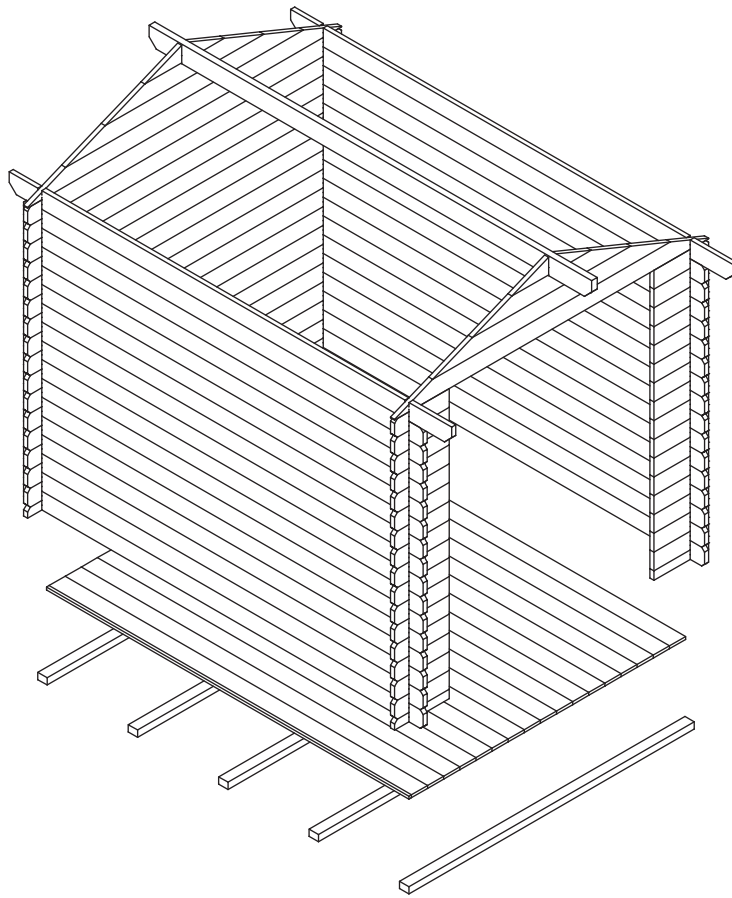

Lagerholzplan und Fundamentplan Emma 28-B

Wir empfehlen als Fundament für Ihr Gartenhaus eine vollflächig,
festgegründete gepflasterte oder betonierte Fläche.
Wahlweise ist auch ein Punkt- oder Streifenfundament möglich.

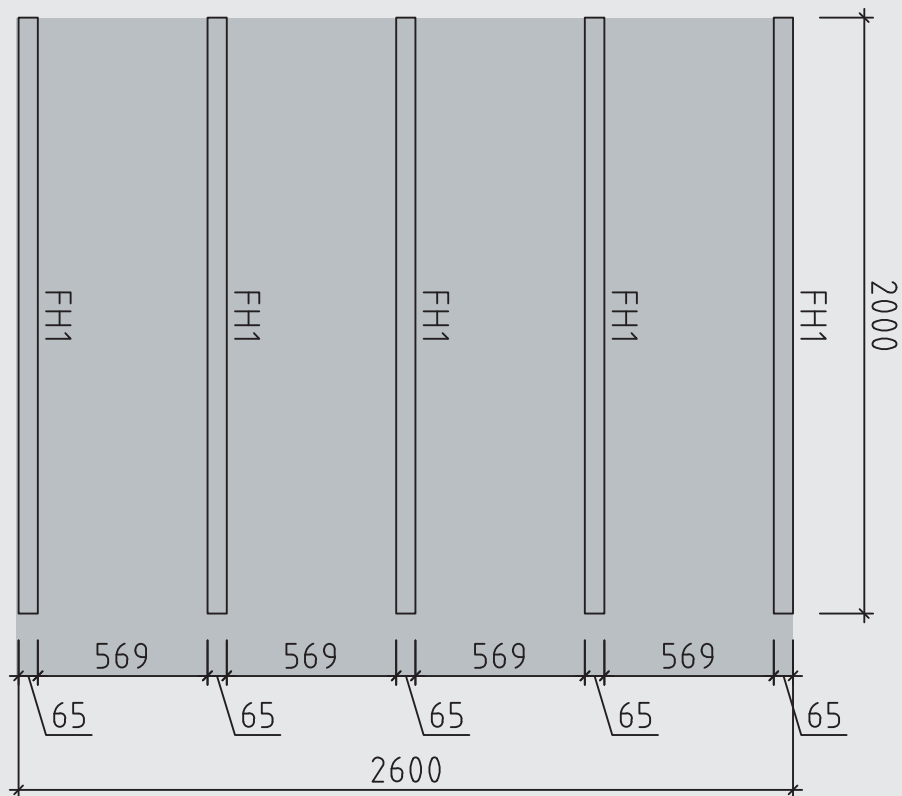





Teileliste 1

Emma 28-B

Pos		Stck	Profil (mm)	Länge (mm)
001		1	28x114	3100
002		1	28x114	3100
003		32	28x114	2800
005		1	28x57	2200
006		16	28x114	2200
010		32	28x114	382
011		2	28x57	383
W1-1		1		
W2-1		1		
FH1	FUNDAMENTHÖLZER 	5	65x44	2000
DB1	DACHBALKEN 	1	40x120	3100
	FUSSBODENBRETTER 	18+1 24+1	113x18 88x18	2540
	DACHBRETTER 	56+1 72+1	113x18 88x18	1300
	ABDECKLEISTEN 	✓	15x28	8,0
	GIEBELDECKLEISTE 	✓	58x18	1380
	GIEBELBRETTER 	22,3° ✓	120x18	1380
	Sturmleisten 	4		1825
	TRAUFELEISTE 40x18 	2	40x18	3100
	TRAUFELEISTE 58x18 	2	58x18	3100
	Giebelsegment 	2		
	TÜR 1425x1840 DIN rechts	1	TU3-GH spez	
	Schlaghölzer 	3		250-400
	Schlossschrauben M8x60, Mutter, U-Scheibe 	12		

Teileliste 2

Emma 28-B

Pos		Stck	Profil (mm)	Länge (mm)
	Schrauben 3,0x30 	16		
	Abdeckleisten			
	Schrauben 3,5x35 	14		
	Traufenleiste 40x18			
	Schrauben 3,5x45 	40		
	Giebelbretter, Giebeldeckleiste Traufenleiste 58x18, Giebelsegment			
	Nägel 2,5x50 	495		
	Dachbretter Fussbodenbretter			
	✓ - bitte selber anpassen!			

Wandplan 1 und 2 Emma 28-B

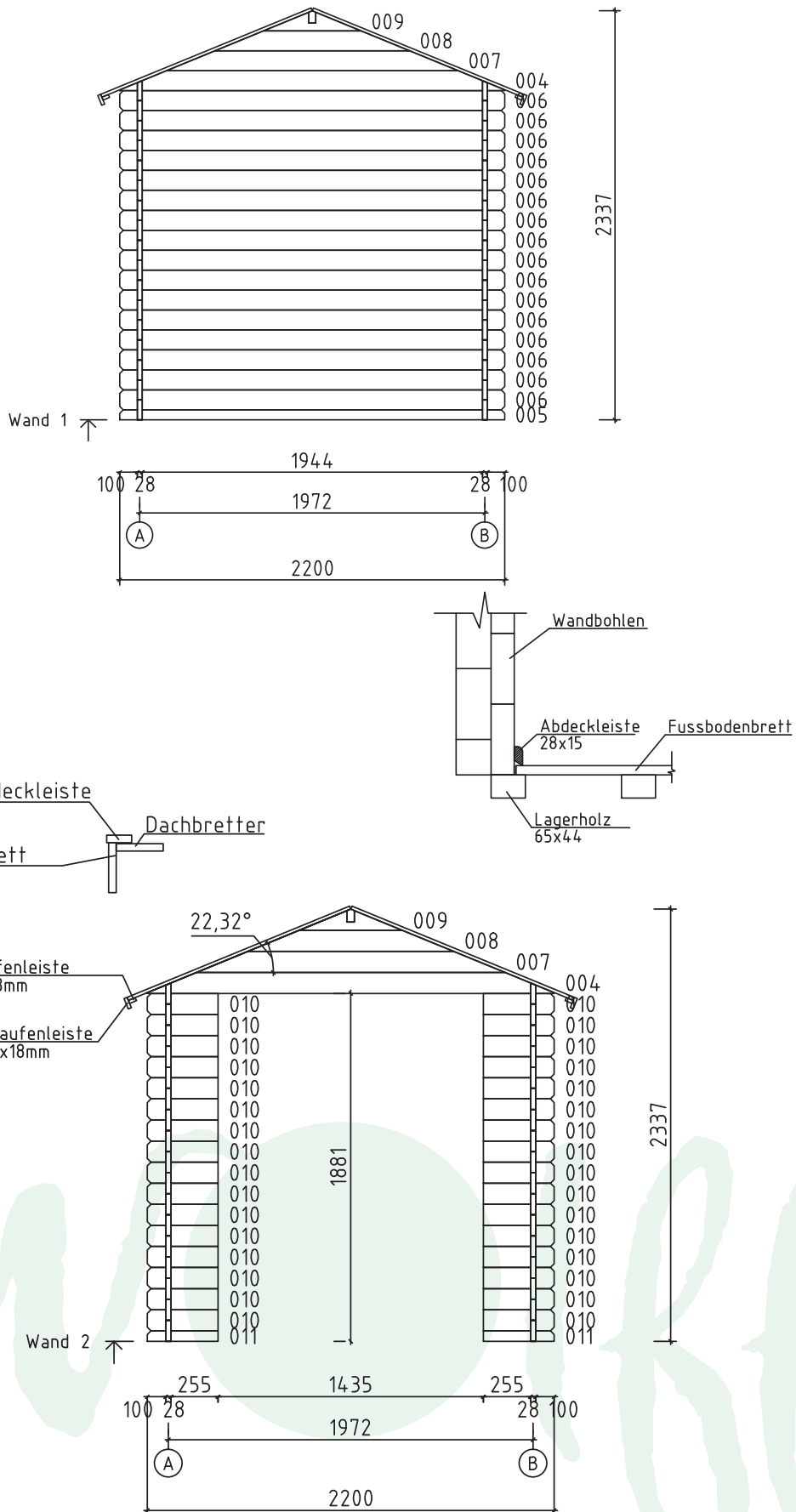

Wandplan A und B Emma 28-B

