

Lisa 44-C XL

Wandaußenmaß: 390 x 390 cm

Bohlenstärke: 44 mm



Kontrolliert durch:

Achtung: Alle angegebenen Maße sind ca.-Maße!

3D-Darstellung Lisa 44-C XL

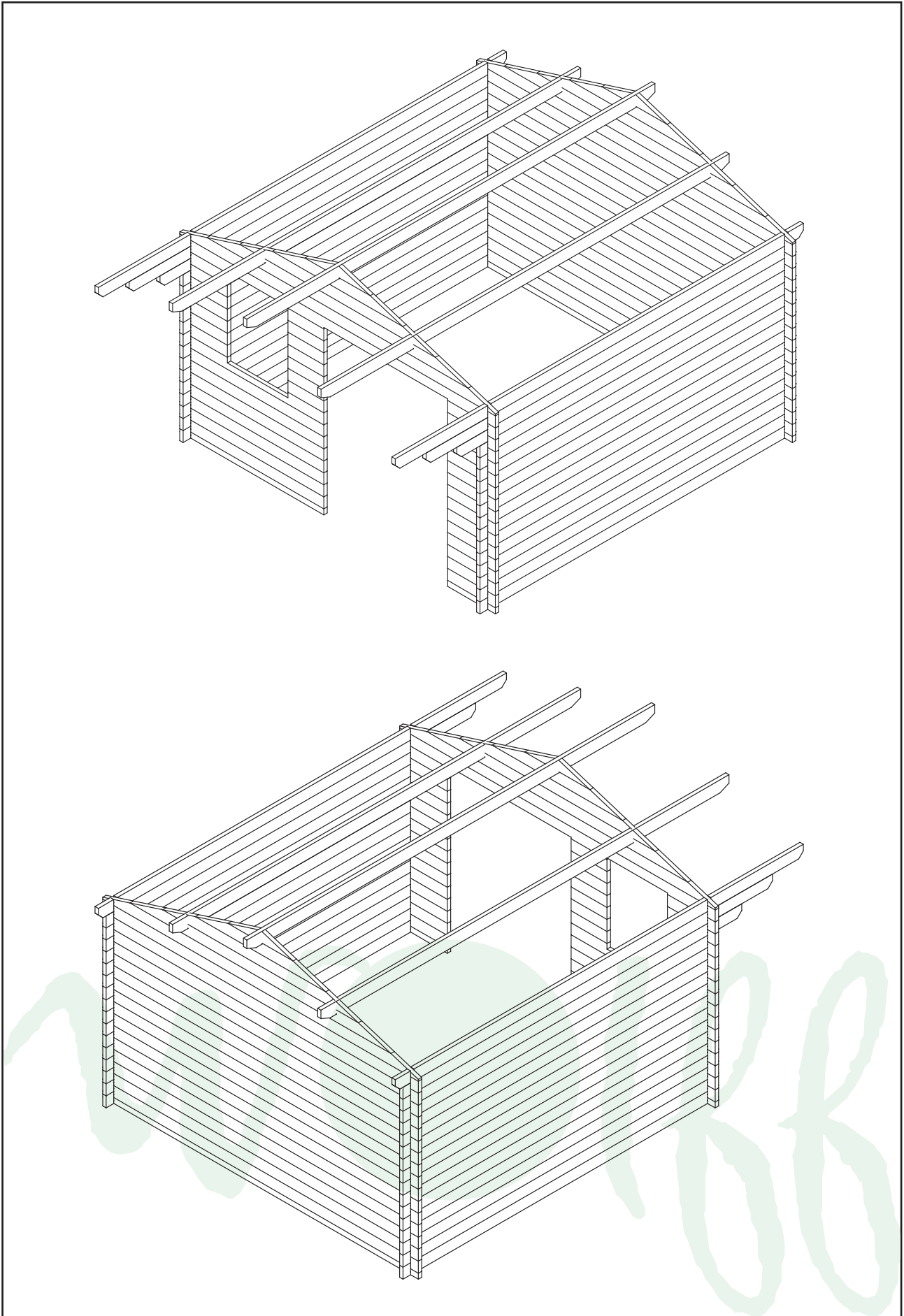

Grundriss Lisa 44-C XL

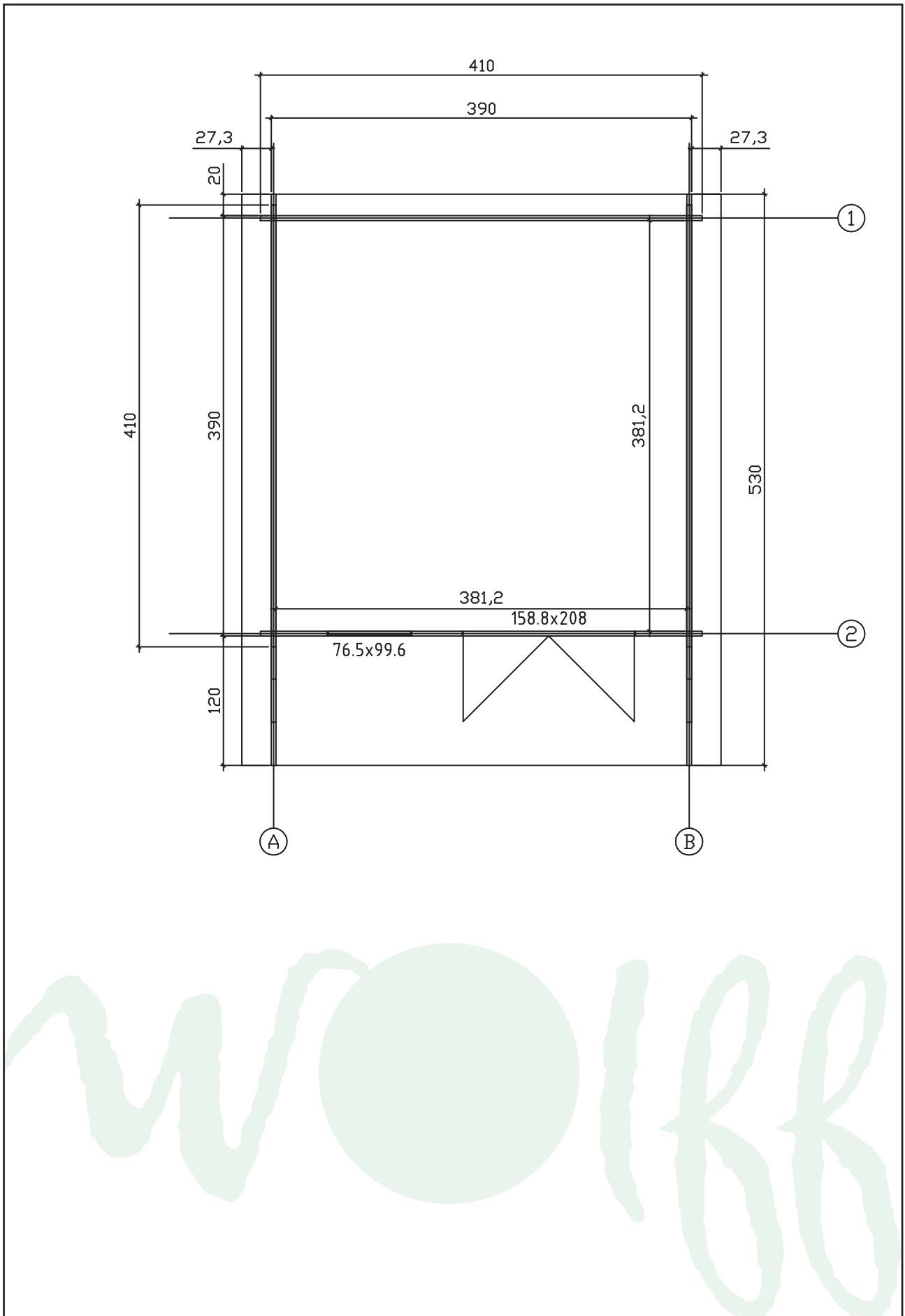





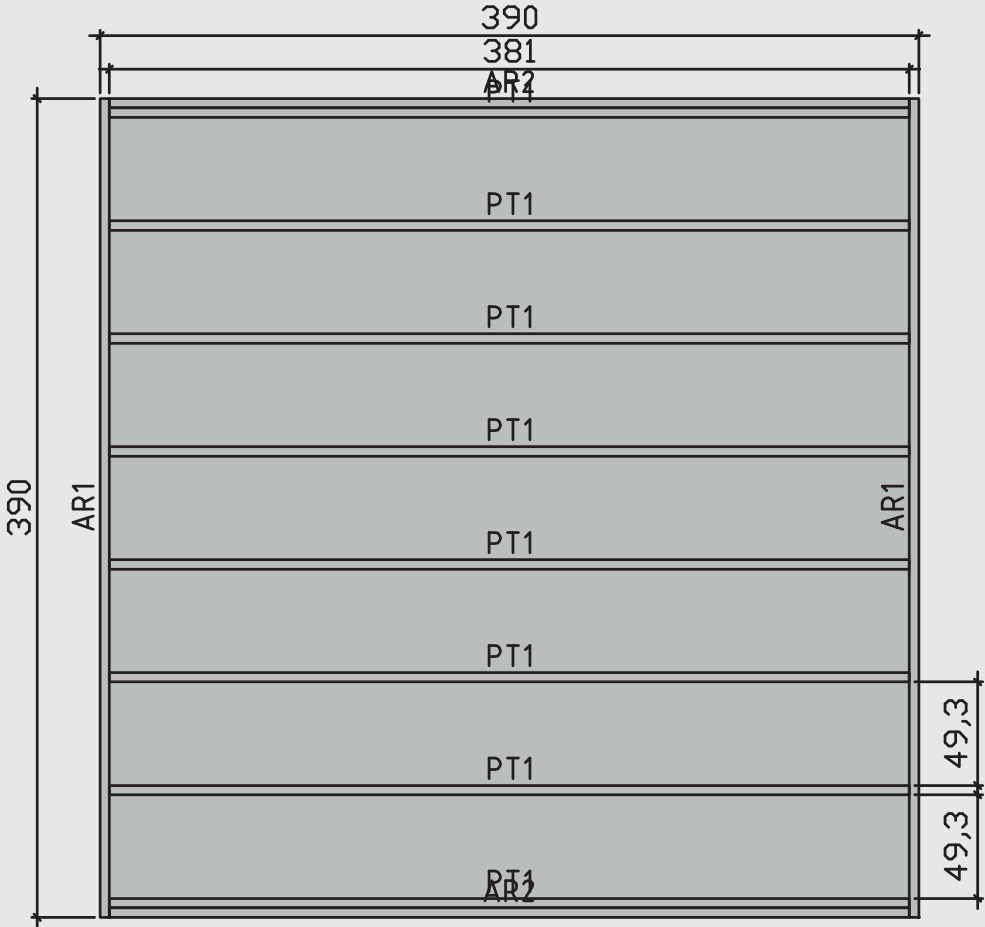



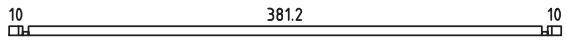
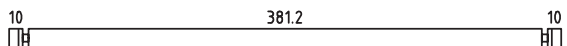
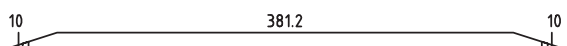
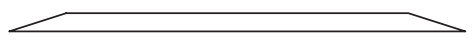
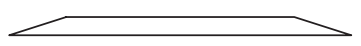
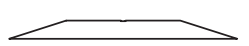

Lagerholzplan und Fundamentplan Lisa 44-C XL

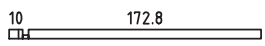
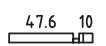
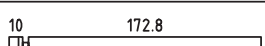
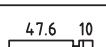
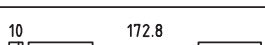
Wir empfehlen als Fundament für Ihr Gartenhaus eine vollflächig,
festgegründete gepflasterte oder betonierte Fläche.
Wahlweise ist auch ein Punkt- oder Streifenfundament möglich.

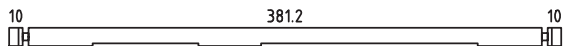
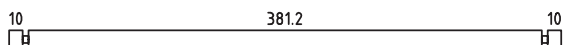
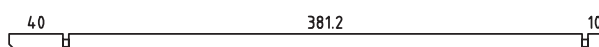
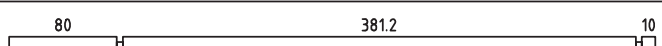

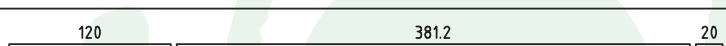

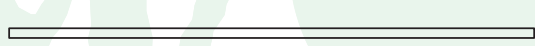
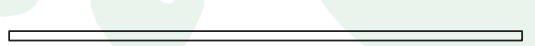

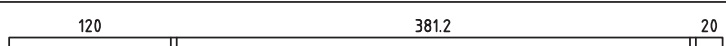





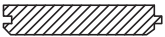

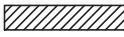



Teileliste 1

Lisa 44-C XL

Pos		Pcs	Profile (cm)	Length (cm)
001		1	4.4x6.8	410
002		16	4.4x13.5	410
003		2	4.4x13.5	410
004		2	4.4x13.5	338.8
005		2	4.4x13.5	254.1
006		2	4.4x13.5	169.4
007		2	4.4x13	40.7
008		2	4.4x13	40.7
009		1	4.4x6.8	187.2
010		1	4.4x6.8	62
011		7	4.4x13.5	187.2
012		22	4.4x13.5	62
013		1	4.4x13.5	187.2
014		7	4.4x13.5	46.6
015		1	4.4x13.5	410
016		28	4.4x13.5	410
017		2	4.4x13.5	440
018		2	4.4x13.5	480
019		1	4.4x13.5	530
020		1	4.4x13.5	530
PT1		8	4.5x7	381
AR1		2	4.5x7	390
AR2		2	4.5x7	381
PR1		2	4.3x14.5	530
PR2		1	4.3x14.5	530

Teileliste 2

Lisa 44-C XL

Pos			Pcs	Profile (cm)	Length (cm)
	WINDOW 76.5x99.6		1		
	DOOR 158.8x208		1		
021	FLOOR BOARDS/FUSSBODEN/LAME DE PLANCHER		34	11.2x1.8	380.7
022	ROOF BOARDS/DACHBRETTER/VOLIGE		96 78	11.2x1.8 13.7x1.8	233.0 233.0
023	ROOF EDGE REINFORCEMENT/TRAUFENLEISTE/TASSEAU		2	2.6x3.2	5300
024	ROOF SIDE BOARDS/TRAUFENBRETT/PLANCHE DE RIVE		2	1.8x9.5	5300
025	FASCIA BOARD/GIEBELBLENDE/PLANCHE DE RIVE (FACADE)		4	1.8x12.0	238.0
026	FASCIA BOARD/GIEBELBLENDE/PLANCHE DE RIVE (FACADE)		4	1.8x6.0	238.0
027	FLOOR EDGE TRIM/FURBLEISTEN/PLINTHE PLANCHER		4	2.0x4.5	381.2
028	DIAMOND/RAUTE/DIAMANT		2	1.8x12	120
029	Nails/Nägel/Clous 2.0 40 mm - For fixing roofing felt fillet (18 x 90 mm)/ Befestigung Giebelabschlußbrett (18 x 90 mm)/ Pour fixer la latte de finition de la couverture (18 x 90 mm)		40		
030	Screws/Schrauben/Vis 4 x 50 mm - For fixing roof side boards and roof edge reinforcement/Befestigung Traufenbretter und Traufenleisten Pour fixer les planches de rive et le tasseau (30 x 34 mm) de renfort		72		
031	Screws/Schrauben/Vis 2.5X25 mm - For fixing window and door trims/ Befestigung Fenster und Türen/P our fixer les croisillons des fenetres et des portes		48		
032	Screws/Schrauben/Vis 4 x 50 mm - For fixing first row of wall logs/ Fixierung des ersten Bohlenkranzes/Pour fixer le premier rang de madrier		6		
033	Nails/Nägel/Clous 2.5 x 50 mm - For fixing floorboards/ Befestigung Fußbodenbretter/Pour fixer les lames de plancher		300		
034	Nails/Nägel/Clous 1.4 x 40 mm - For fixing floor edge trims (19 x 19 mm)/ Befestigung Fußleisten/Pour fixer les plinthes du plancher (19 x 19 mm)		30		
035	Screws/Schrauben/Vis 4x70 mm - For bearers/ Befestigung Fundamentbalken/Pour fixer les solives		18		
036 KL 1	METAL STORM BRACE/GEWINDESTANGE/TIGE FILETEE		5	M10	200
037	Shim, Nut/Mutter, U-Scheibe/ECROU,Rondelle - M10 mm - For fixing storm braces/Pour fixer les anti-tempete/Für Sturmleisten		8	M10	
038	CONNECTION NUT/ÜBERWURFMUTTER/ECROU DE RACCORDEMENT		4	M10	

Wandplan 1 und 2

Lisa 44-C XL

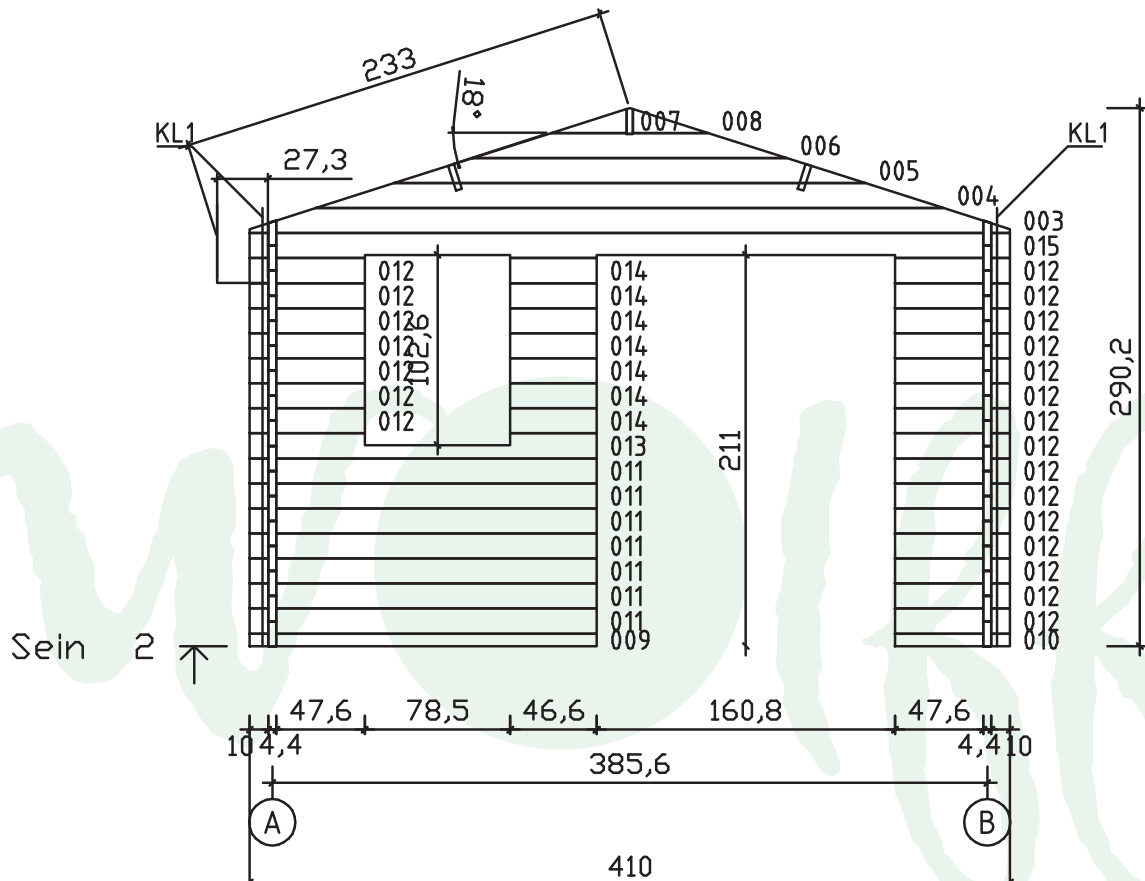
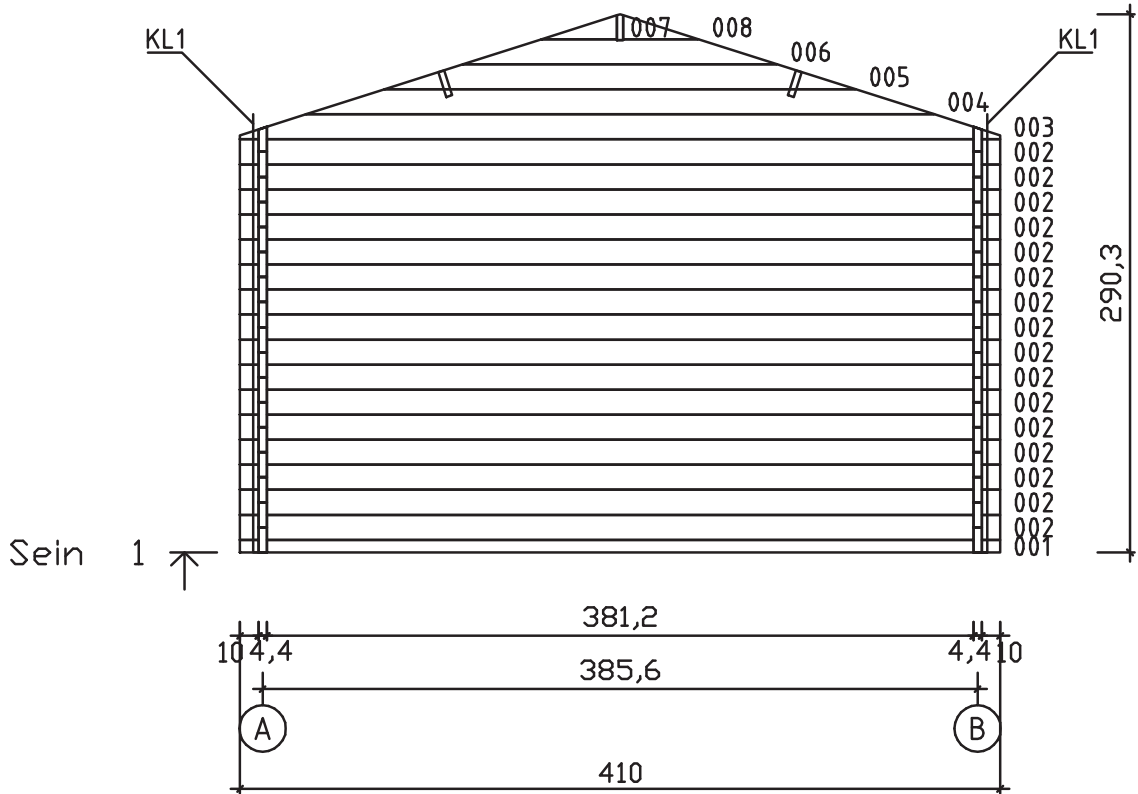

Wandplan A und B Lisa 44-C XL

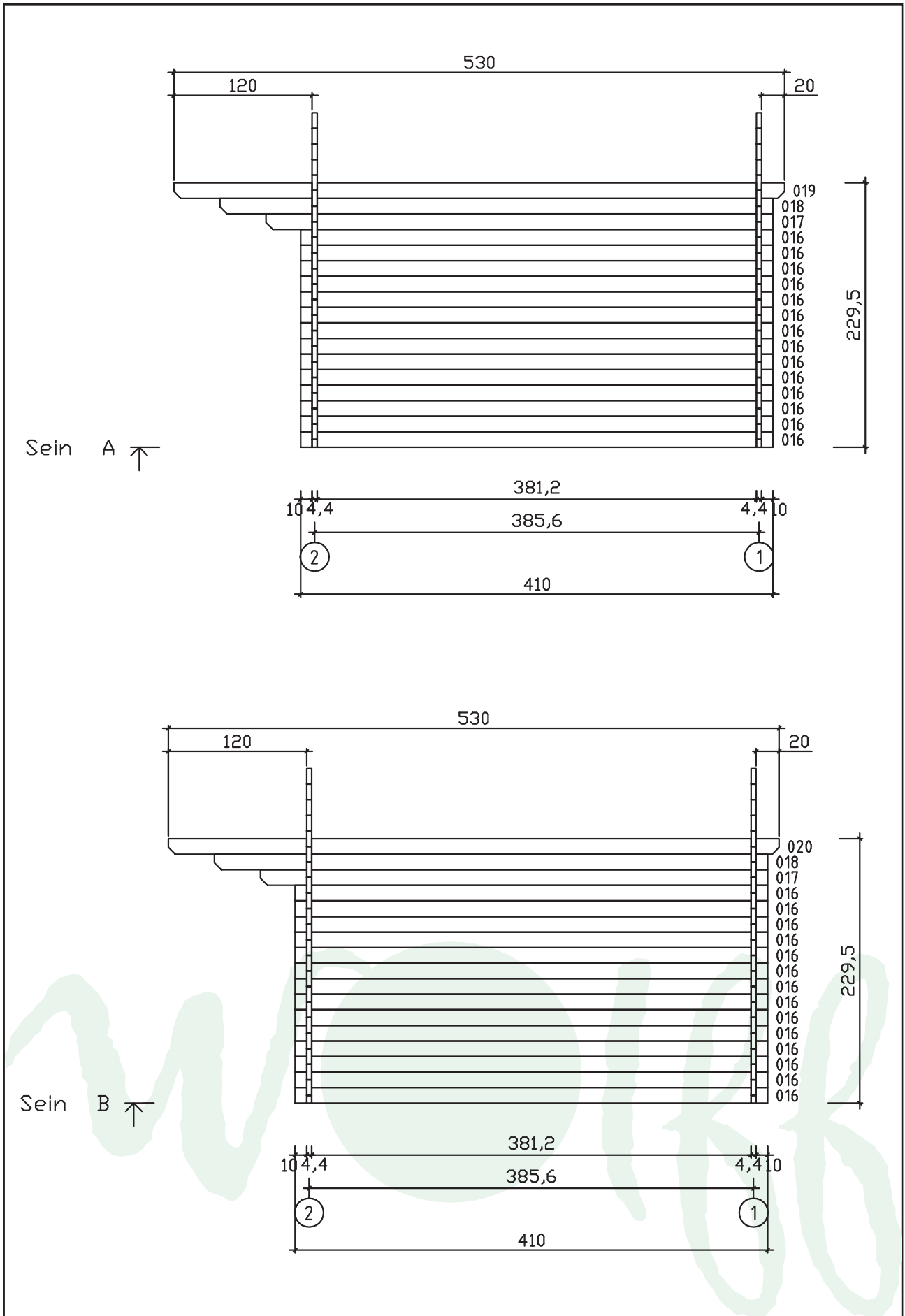

Montage / Zusatzinformation

Lisa 44-C XL

