

# Lisa 44-B

Wandaußenmaß: 360 x 360 cm

Bohlenstärke: 44 mm



Lisa 44-C

Kontrolliert durch:

Achtung: Alle angegebenen Maße sind ca.-Maße!

# 3D-Darstellung Lisa 44-B

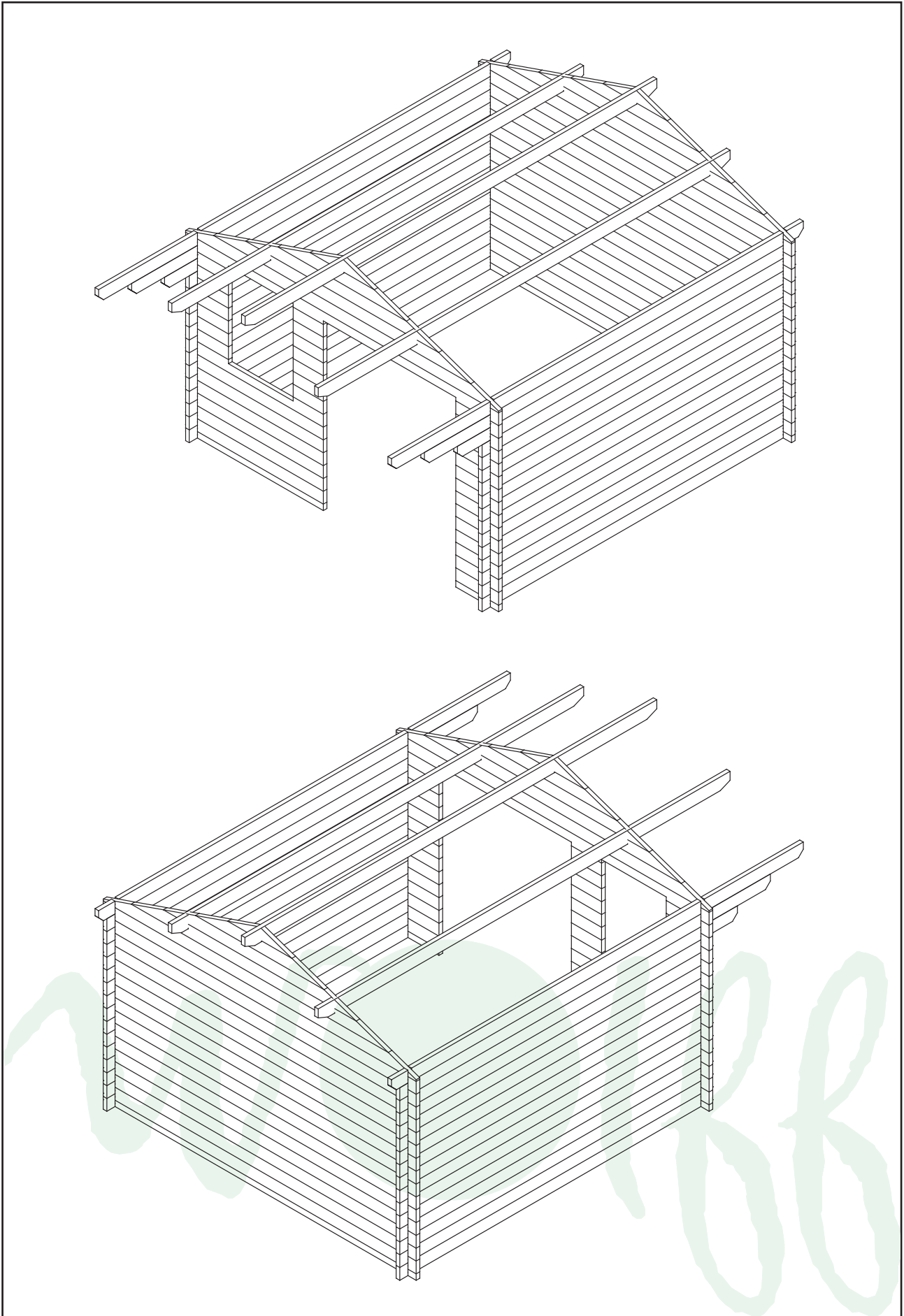

# Grundriss Lisa 44-B

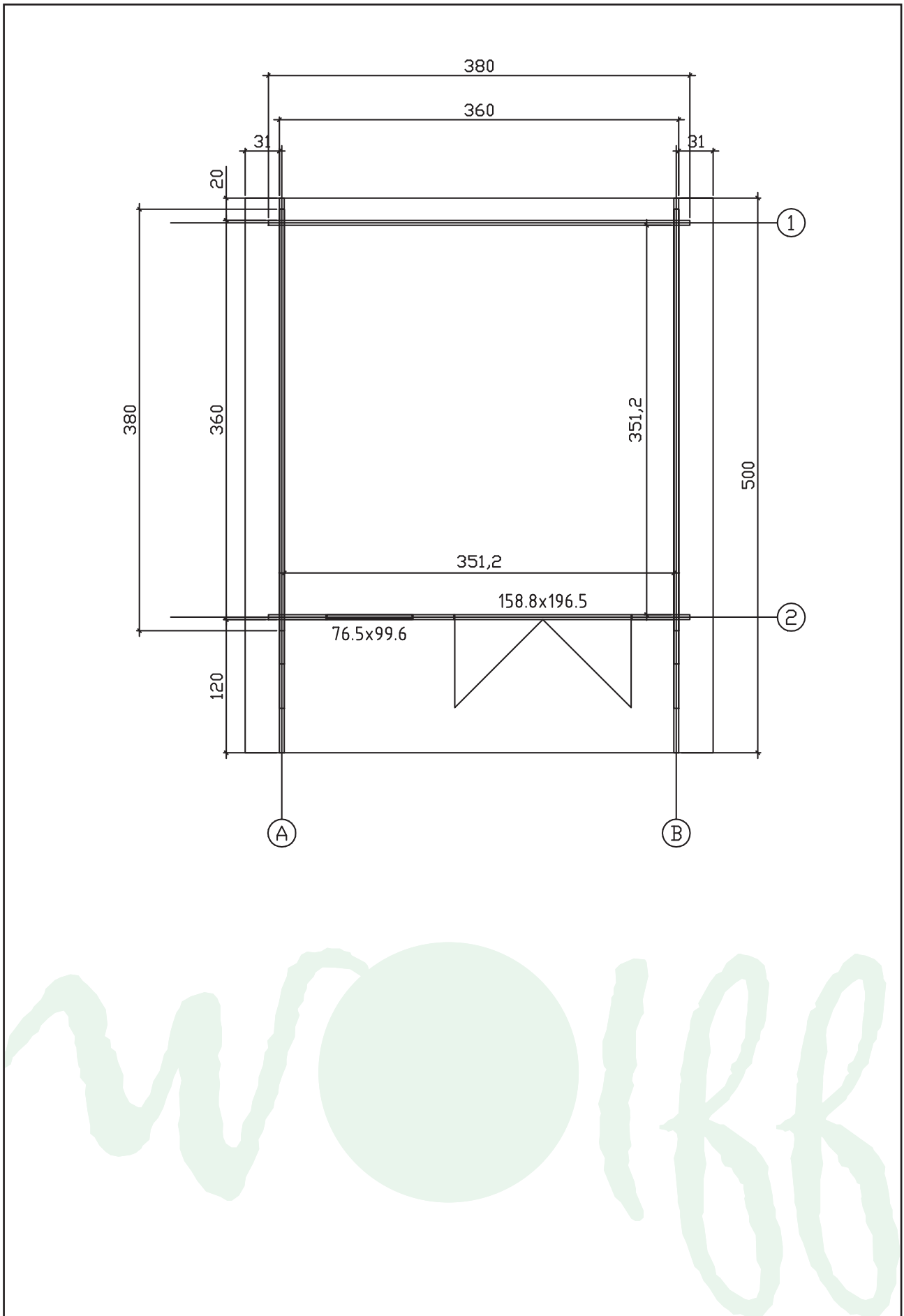





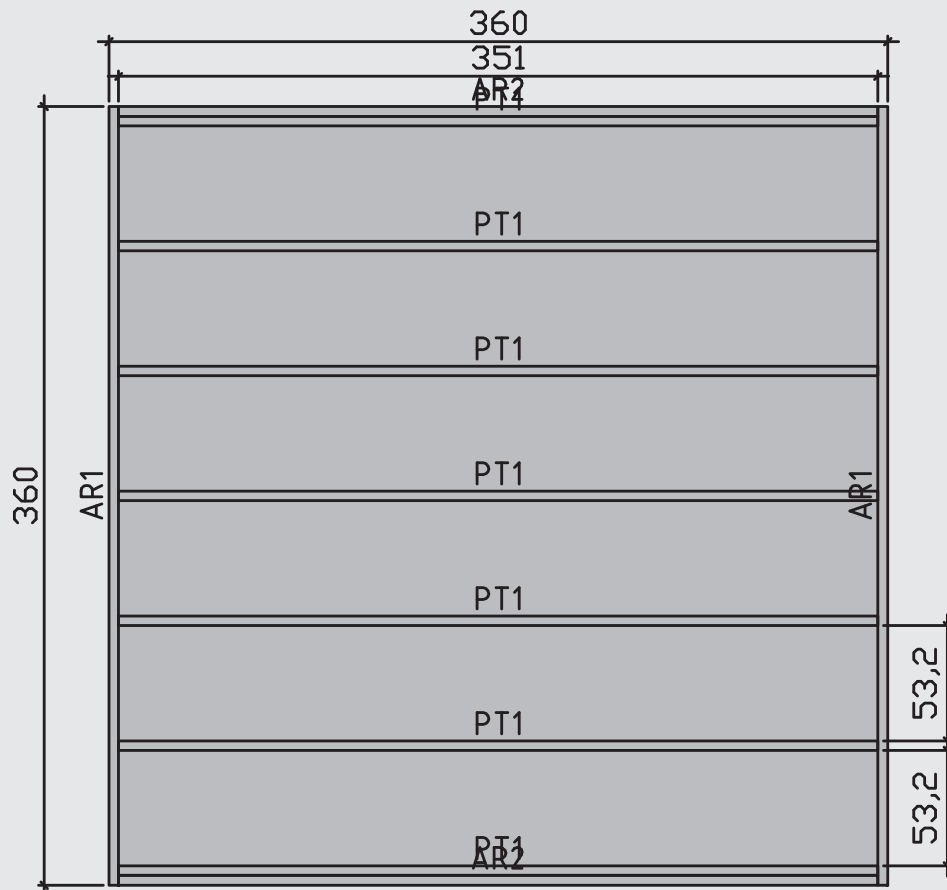





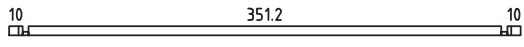
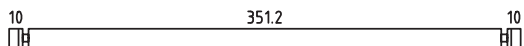
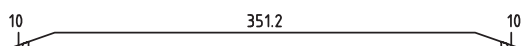
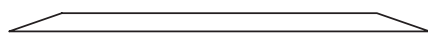
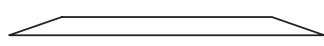
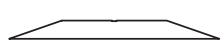

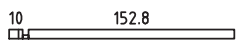

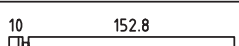

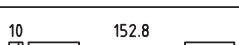
# Lagerholzplan und Fundamentplan Lisa 44-B

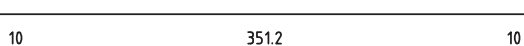
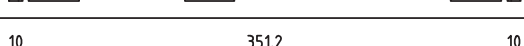
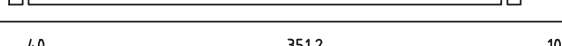
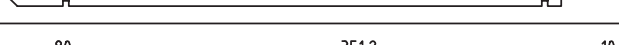
Wir empfehlen als Fundament für Ihr Gartenhaus eine vollflächig,  
festgegründete gepflasterte oder betonierte Fläche.  
Wahlweise ist auch ein Punkt- oder Streifenfundament möglich.



# Teileliste 1

## Lisa 44-B

Pos		Arv	Profiil (cm)	Pikkus (cm)
001		1	4.4x6.8	380
002		15	4.4x13.5	380
003		2	4.4x13.5	380
004		2	4.4x13.5	312.2
005		2	4.4x13.5	234.1
006		2	4.4x13.5	156.1
007		2	4.4x12.9	37.4
008		2	4.4x12.9	37.4
009		1	4.4x6.8	167.2
010		1	4.4x6.8	52
011		6	4.4x13.5	167.2
012		21	4.4x13.5	52
013		1	4.4x13.5	167.2
014		7	4.4x13.5	36.6
015		1	4.4x13.5	380
016		26	4.4x13.5	380
017		2	4.4x13.5	410
018		2	4.4x13.5	450
019		1	4.4x13.5	500
020		1	4.4x13.5	500
PT1	FOUNDATION/FUNDAMENT/SOLIVE 	7	4.5x7	351
AR1	FOUNDATION/FUNDAMENT/SOLIVE 	2	4.5x7	360
AR2	FOUNDATION/FUNDAMENT/SOLIVE 	2	4.5x7	351
PR1	ROOF BEAM/DACHBAALKEN/PANNE 351.2 	2	4.3x14.5	500
PR2	ROOF BEAM/DACHBAALKEN/PANNE 351.2 	1	4.3x14.5	500

Leht 1/2



# Wandplan 1 und 2 Lisa 44-B

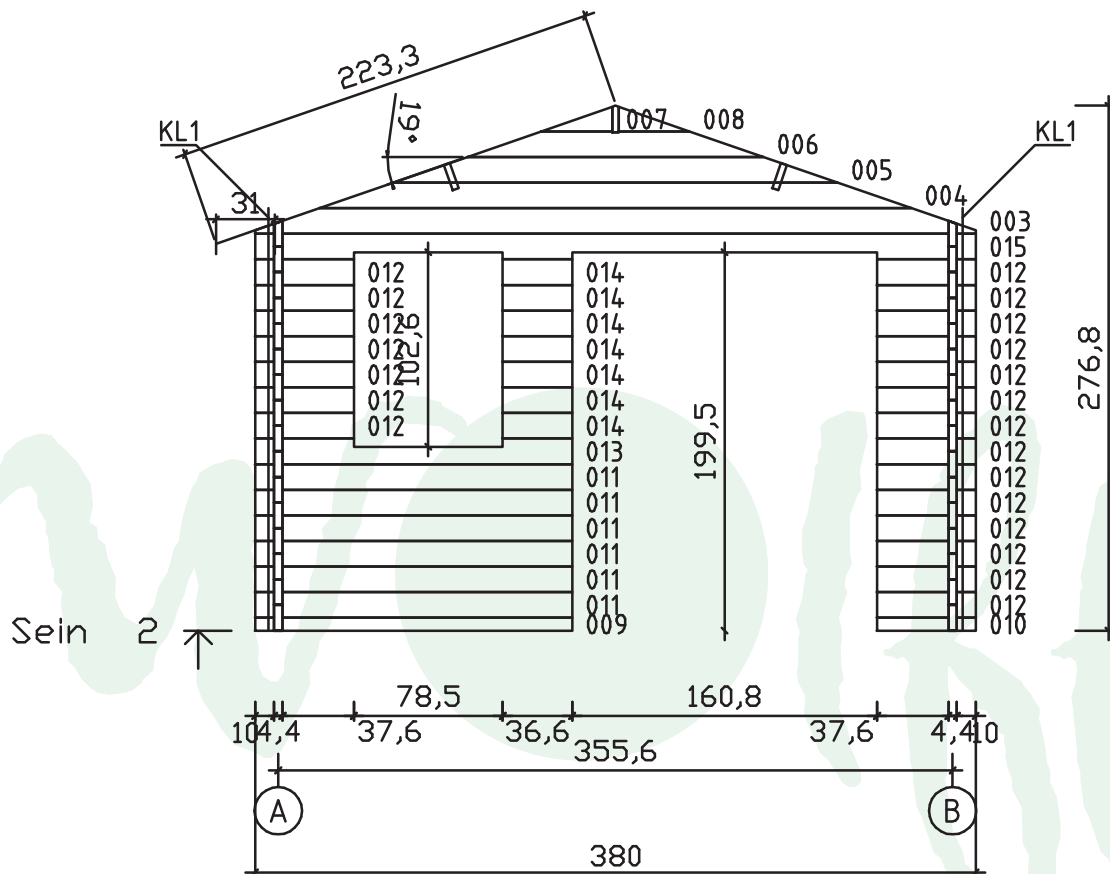
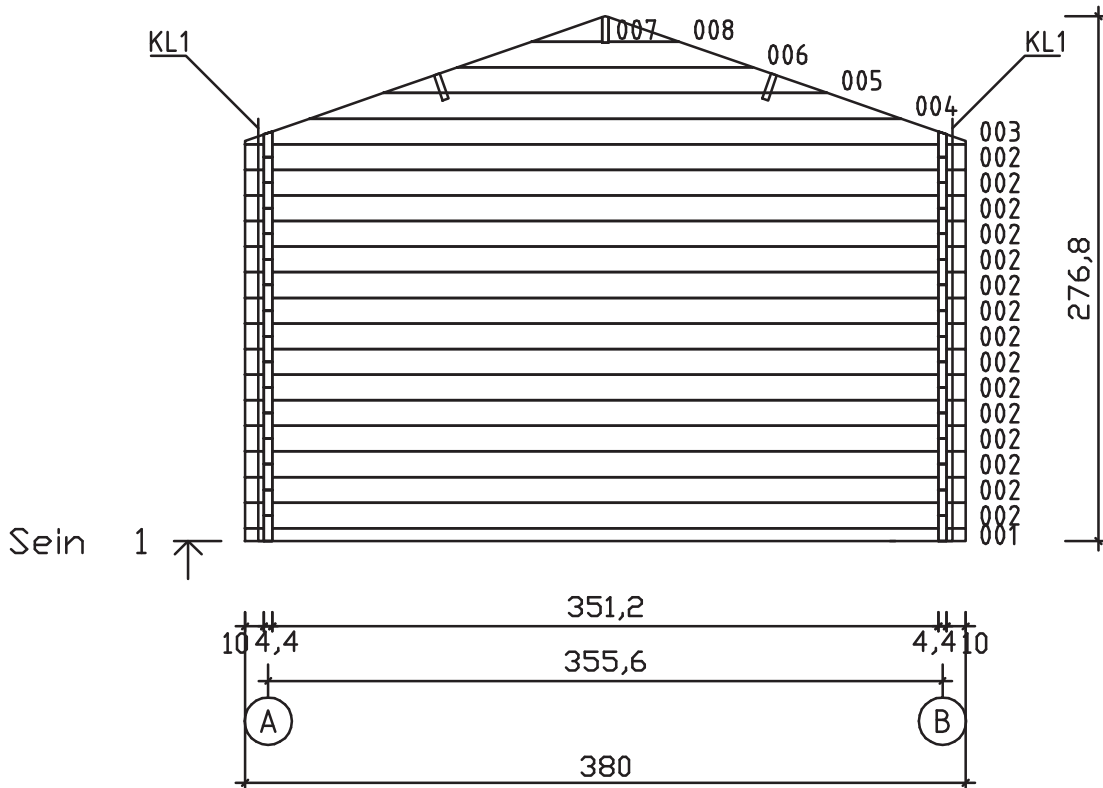

# Wandplan A und B

## Lisa 44-B

