

# Metz B

Wandaußenmaß: 400 x 300 cm  
Bohlenstärke: 28 mm



Kontrolliert durch:

Achtung: Alle angegebenen Maße sind ca.-Maße!

# 3D-Ansicht Metz B

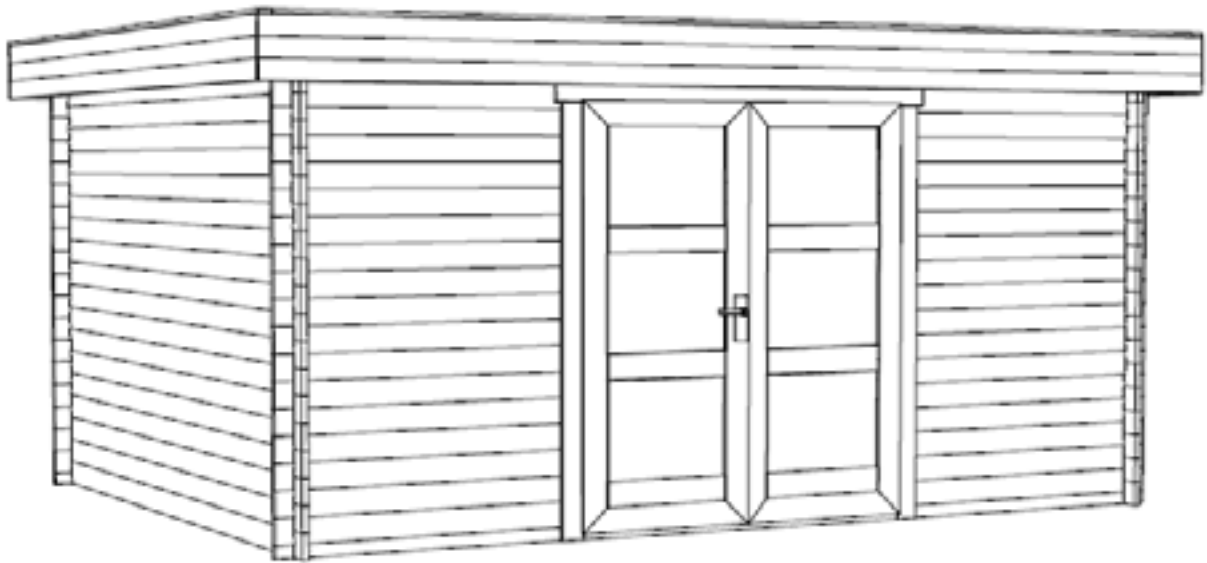

# Grundriss Metz B

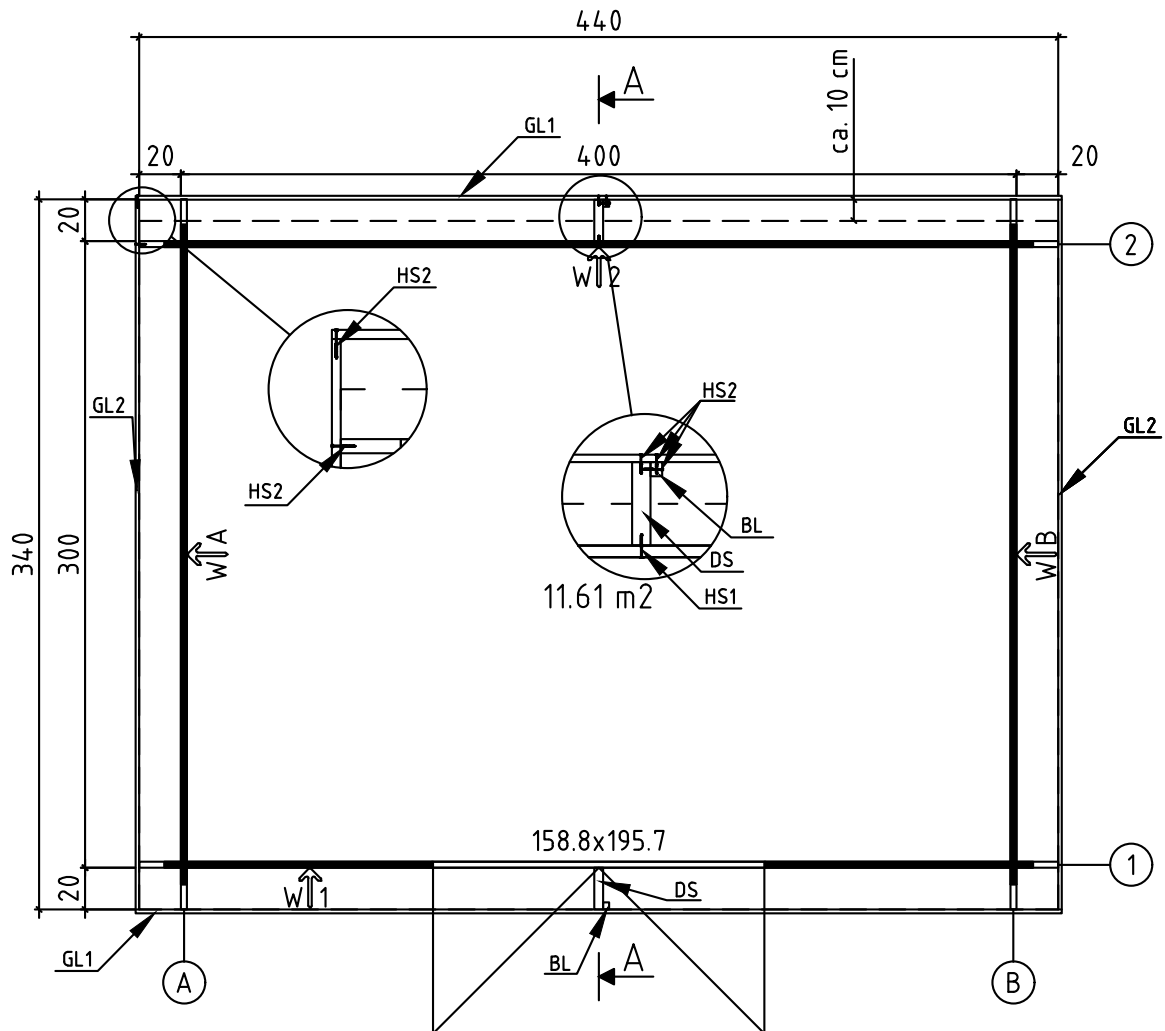

# Dachplan Metz B

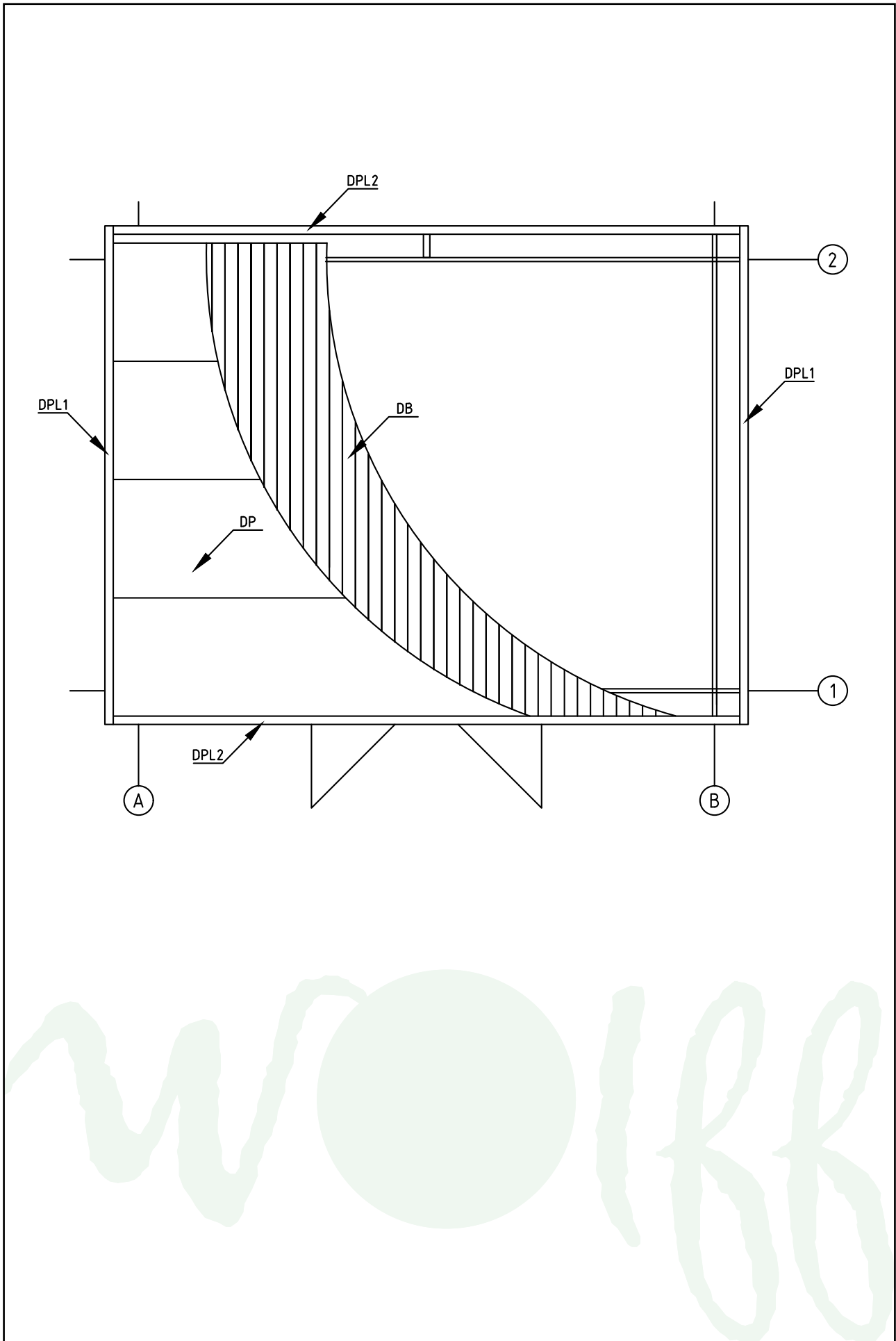



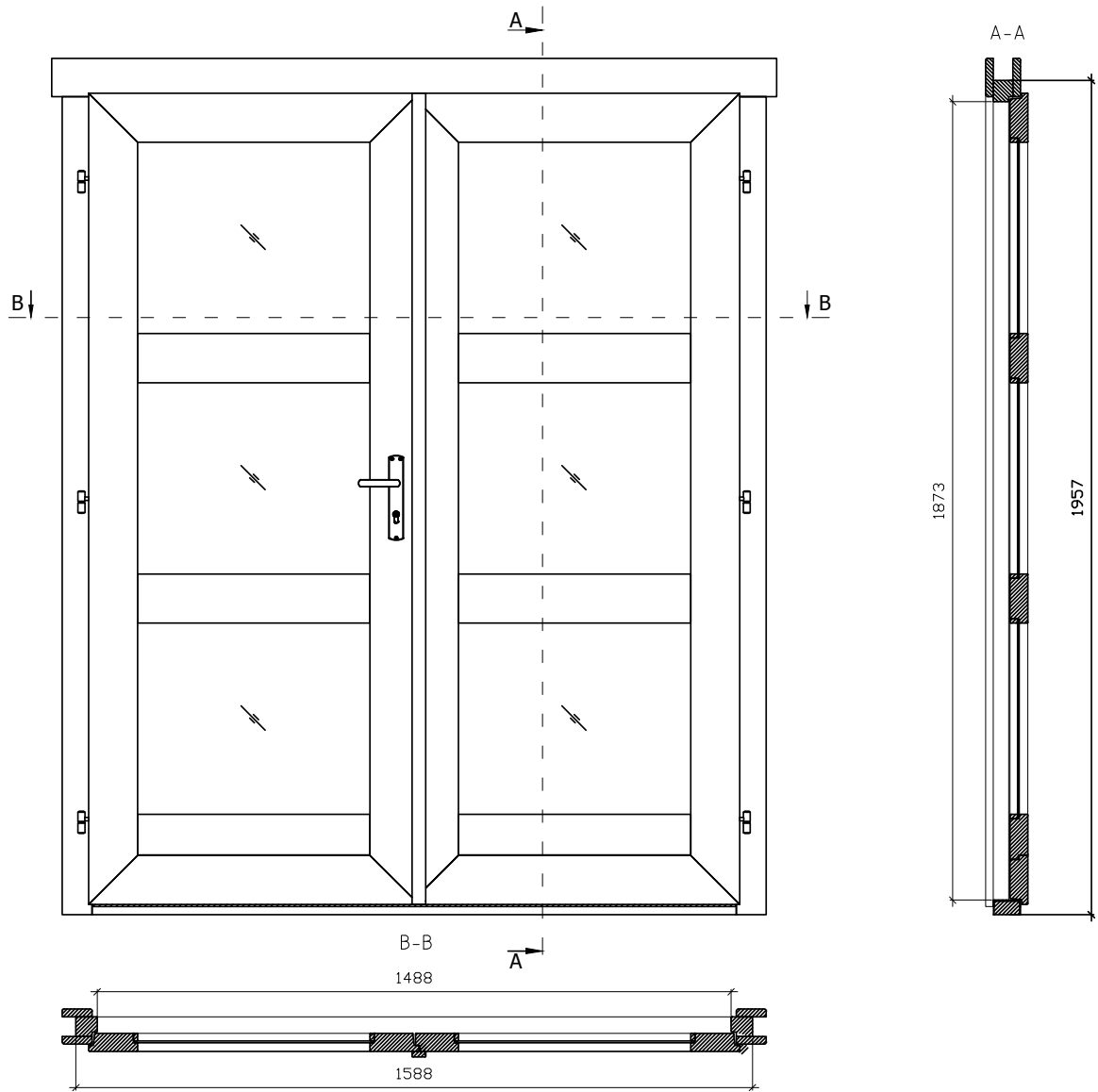





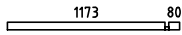
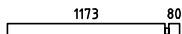
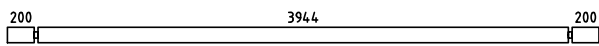
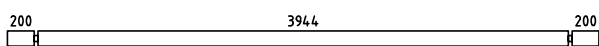
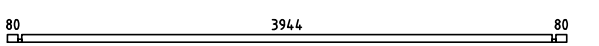
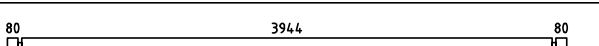
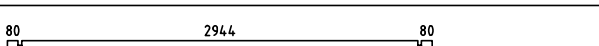
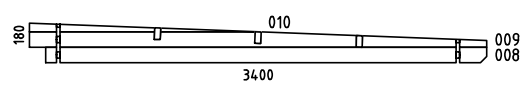
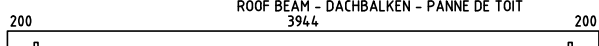



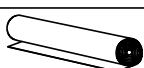

# Fensterdetails Metz B

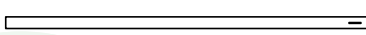











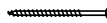
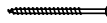
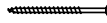
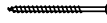

# Teilleiste 1

## Metz B

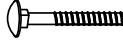
Pos		Q	P (mm)	L (mm)
001		2	28x57	1281
002		34	28x114	1281
003		1	28x114	4400
004		2	28x114	4400
005		1	28x57	4160
006		17	28x114	4160
007		34	28x114	3160
WA-1		1		
WB-1		1		
PR21	 ROOF BEAM - DACHBALKEN - PANNE DE TOIT	3	44x140	4400
RB	ROOF BOARDS - DACHBRETTER - VOLIGES 	49	90x18	3300
DPL1	ROOFING FELT FILLET - DACHPAPPENLEISTE - BAGUETTE DE FIXATION DU FEUTRE BITUMEUX 	2	18x58	3440
DPL2	ROOFING FELT FILLET - DACHPAPPENLEISTE - BAGUETTE DE FIXATION DU FEUTRE BITUMEUX 	2	18x58	4325
	ROOFING FELT (STRIP) - DACHPAPPE (BAHNEN) - FEUTRE BITUMEUX (BANDE) 	4		4500
DRV-1	ROOF EDGE REINFORCEMENT - DACHRANDVERSTÄRKUNG - CORNIERE DE RENFORT DE BORD DE TOIT 	4	28x34	200
DRV-2	ROOF EDGE REINFORCEMENT - DACHRANDVERSTÄRKUNG - CORNIERE DE RENFORT DE BORD DE TOIT 	4	28x34	1948
DS	DISTANCE SPACERS FOR GABLE MOULDING - DACHSTÜZEN - SUPPORTS EXTENSION TOITURE 	2	44x120	200
KFS-1	STORM PROTECTION - STURMLEISTE - LATTE ANTI-TEMPETE 	4	22x45	2500
BL	FIXING SLAT FOR DISTANCE SPACERS - BEFESTIGUNGSLEISTE - RENFORTS PLANCHES DE RIVES 	2	28x34	220
GL2	GABLE MOULDING - GIEBELLEISTE - PLANCHE DE RIVE 	6	18x90	3400
GL1	GABLE MOULDING - GIEBELLEISTE - PLANCHE DE RIVE 	6	18x90	4436
HS9	SCREW FOR GABLE MOULDING - SCHRAUBEN FÜR GIEBELLEISTE - VIS POUR FIXATION PLANCHE DE RIVE 	85	3.5x50	
HS4	SCREW FOR DOOR FILLET - SCHRAUBE ZUR BEFESTIGUNG TÜRLEISTE - VIS POUR FIXATION BAGUETTE D'ARRET DE PORTE 	5	3x30	
HS12	SCREW FOR ROOF EDGE REINFORCEMENT - SCHRAUBEN FÜR DACHRANDVERSTÄRKUNG - VIS POUR FIXATION CORNIERE RENFORT DE BORD DE TOIT 	28	4x40	

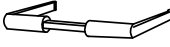
# Teileliste 2

## Metz B

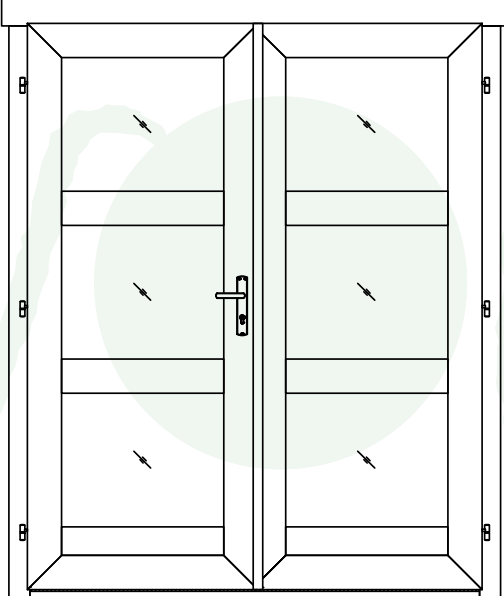
Pos			Q	P (mm)	L (mm)
HS18	SCREW FOR ROOF BEAMS - SCHRAUBEN FÜR DACHBALKEN - VIS POUR FIXATION PANNES DE TOIT		10	5x120	
HS18	SCREW FOR GABLE - SCHRAUBEN FÜR GIEBEL - VIS POUR FIXATION DES PIGNONS		6	5x120	
HS16	SCREW FOR FOUNDATION - SCHRAUBEN ZUR BEFESTIGUNG FUNDAMENT - VIS DE FIXATIONS DES POUTRELLES DE FONDATIONS		4	5x90	
HS16	SCREW FOR DOOR JAMB - SCHRAUBE FÜR TÜRRAHMEN - VIS DE FIXATION PARTIE HAUTE AVEC MONTANTS DU CADRE DE PORTE		4	5x90	
SH28	HAMMER BLOCK - SCHLAGHOLZ - CALLE DE FRAPPE		1		
SFS	NUT FOR STORM PROTECTION - SCHRAUBENMUTTER FÜR STURMLEISTE - ECROU POUR LATTE ANTI-TEMPETE		8	D6	
NF4	ZN NAIL FOR ROOF - ZN NÄGEL FÜR DACHBRETTER - POINTE POUR FIXATION VOLIGES DE TOIT		258	2x50	
NF5	ZN NAIL FOR ROOFING FELT FILLET - ZN NÄGEL FÜR DACHPAPPENLEISTE - POINTE POUR BAGUETTE DE FIXATION FEUTRE BITUMEUX		36	2x40	
NF6	ROOFING NAILS FOR ROOFING FELT - NÄGEL FÜR DACHPAPPE - POINTE POUR FIXATION FEUTRE BITUMEUX		155	2.8x15	
BFS	BOLT FOR STORM PROTECTION - BOLZEN FÜR STURMLEISTE - BOULON POUR LATTE ANTI-TEMPETE		8	6x60	
DFS	WASHER FOR STORM PROTECTION - DICHTSCHEIBE FÜR STURMLEISTE - RONDELLE POUR LATTE ANTI-TEMPETE		8	D6	
TL4	DOOR HANDLE FITTINGS - TÜRGRIF - POIGNEE DE PORTE		1		
TL5	SET OF DOOR LOCK COVERS - SCHLOSSBLENDEN - SET DE GARNITURES DE PORTE		1		
	CYLINDER LOCK - ZYLINDERSCHLOSS - BARILLET DE PORTE		1	30x35	
	MALE BOLT HINGE FOR DOOR - TÜRRIEGEL - PARTIE MALE DE PAUMELLE DE PORTE		6	16x52	
	STRIKER FOR BARREL BOLT - HÜLSE FÜR GRENDDELRIEGEL - GACHE AU SOL DU TARGETTE		2		
	DOOR - TÜR - PORTE 1588x1957		TUK.3.030.MVV.MM MGC	1	

# Wandplan 1 Metz B

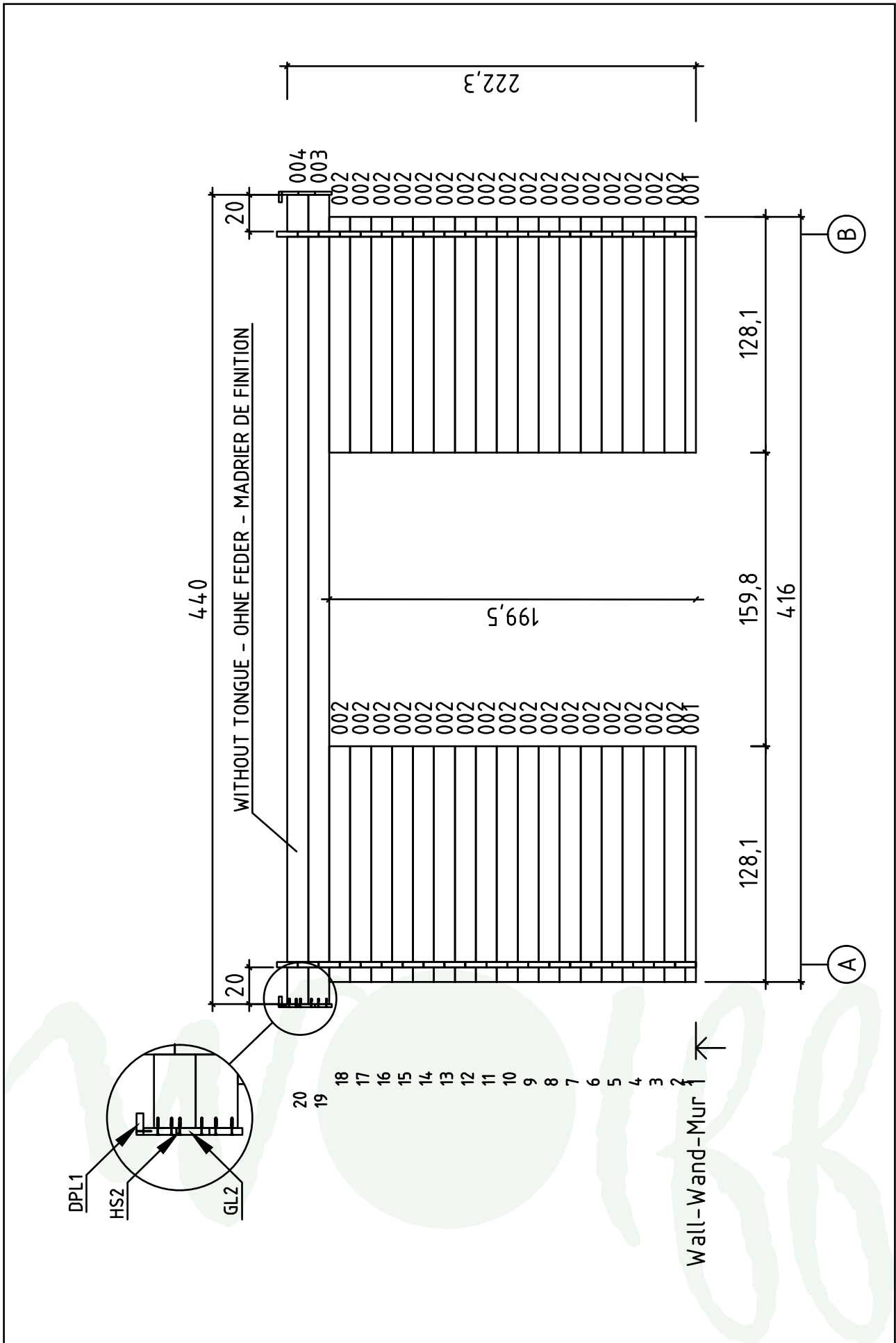



# Wandplan 2 Metz B

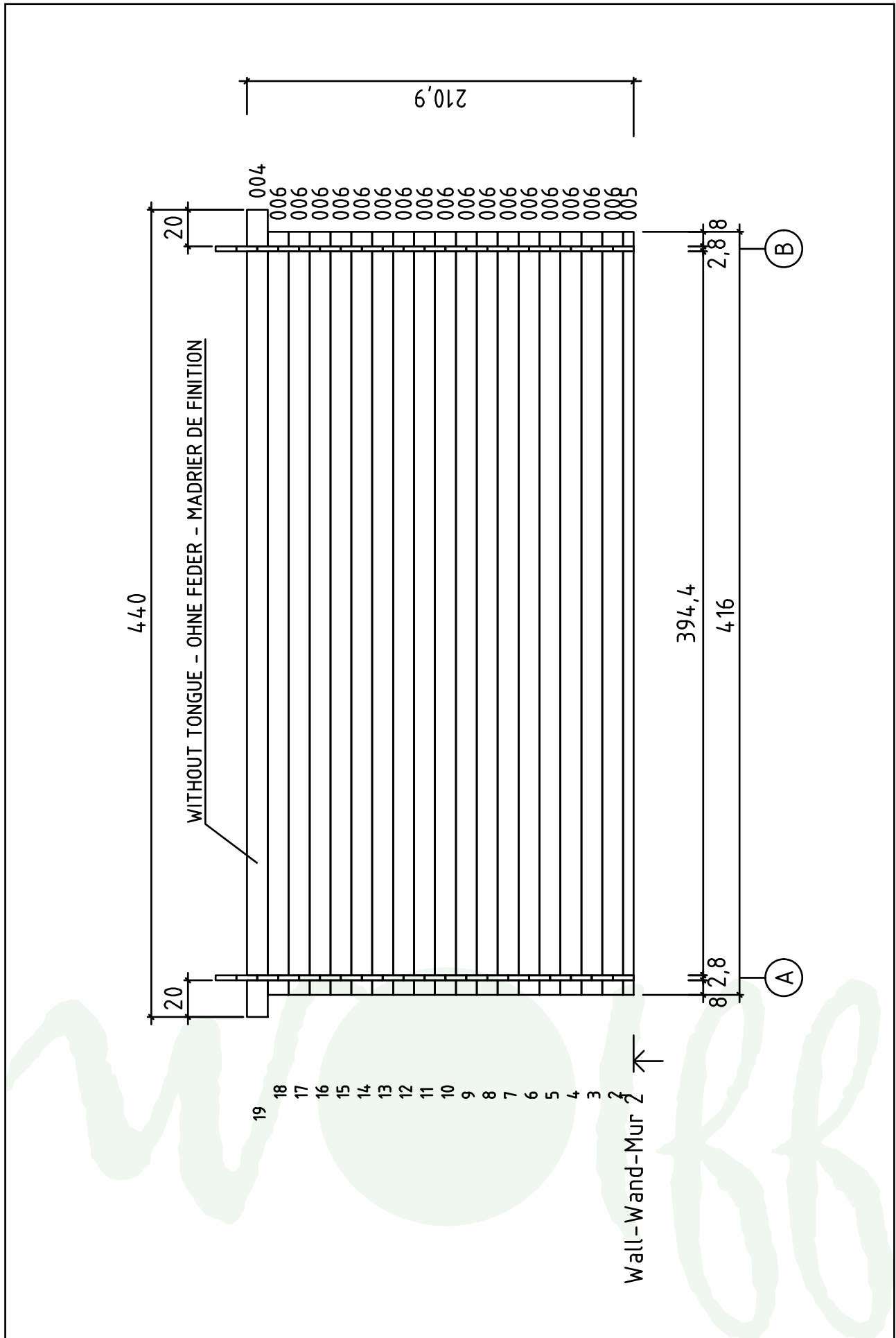

# Wandplan A Metz B

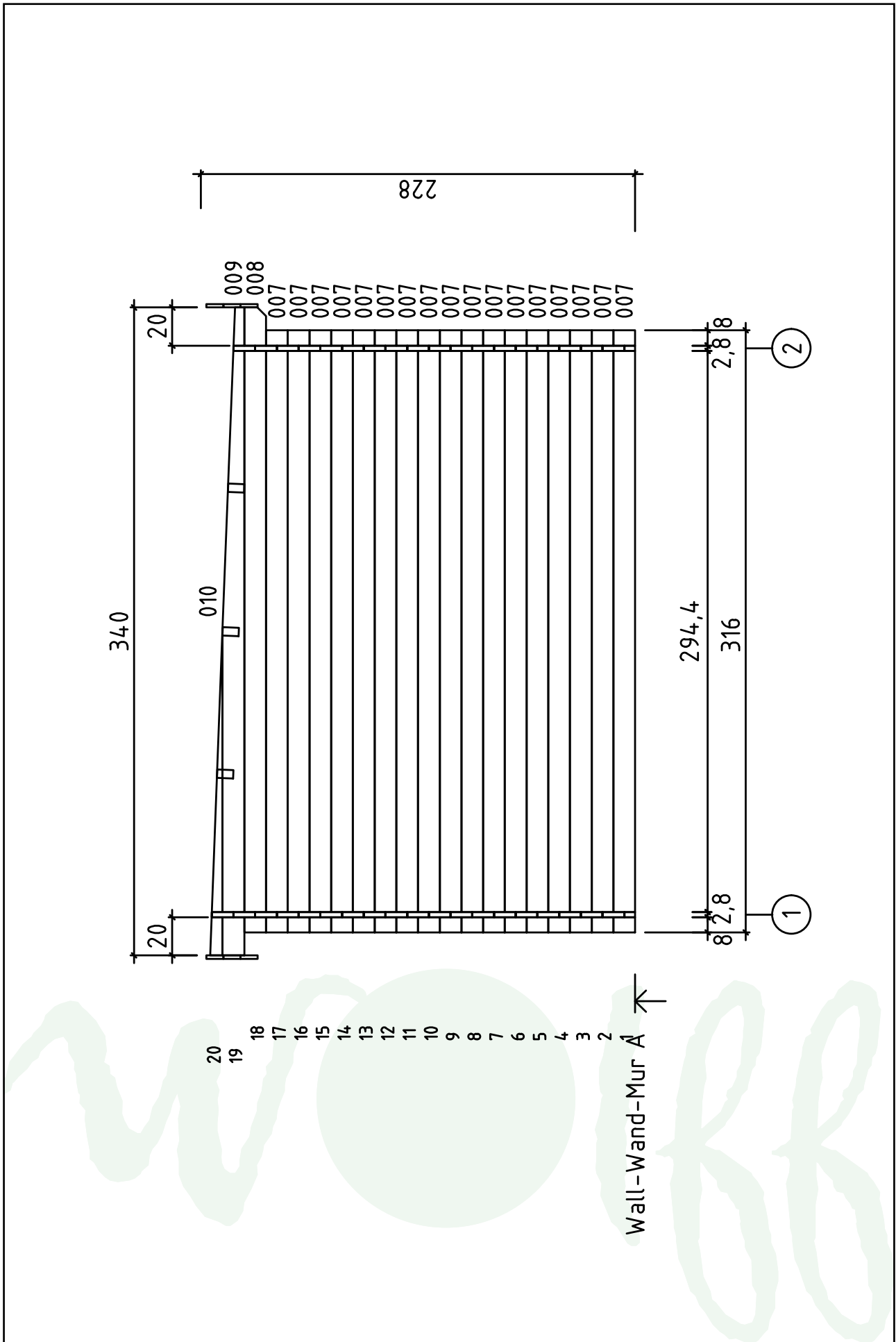

# Wandplan B Metz B

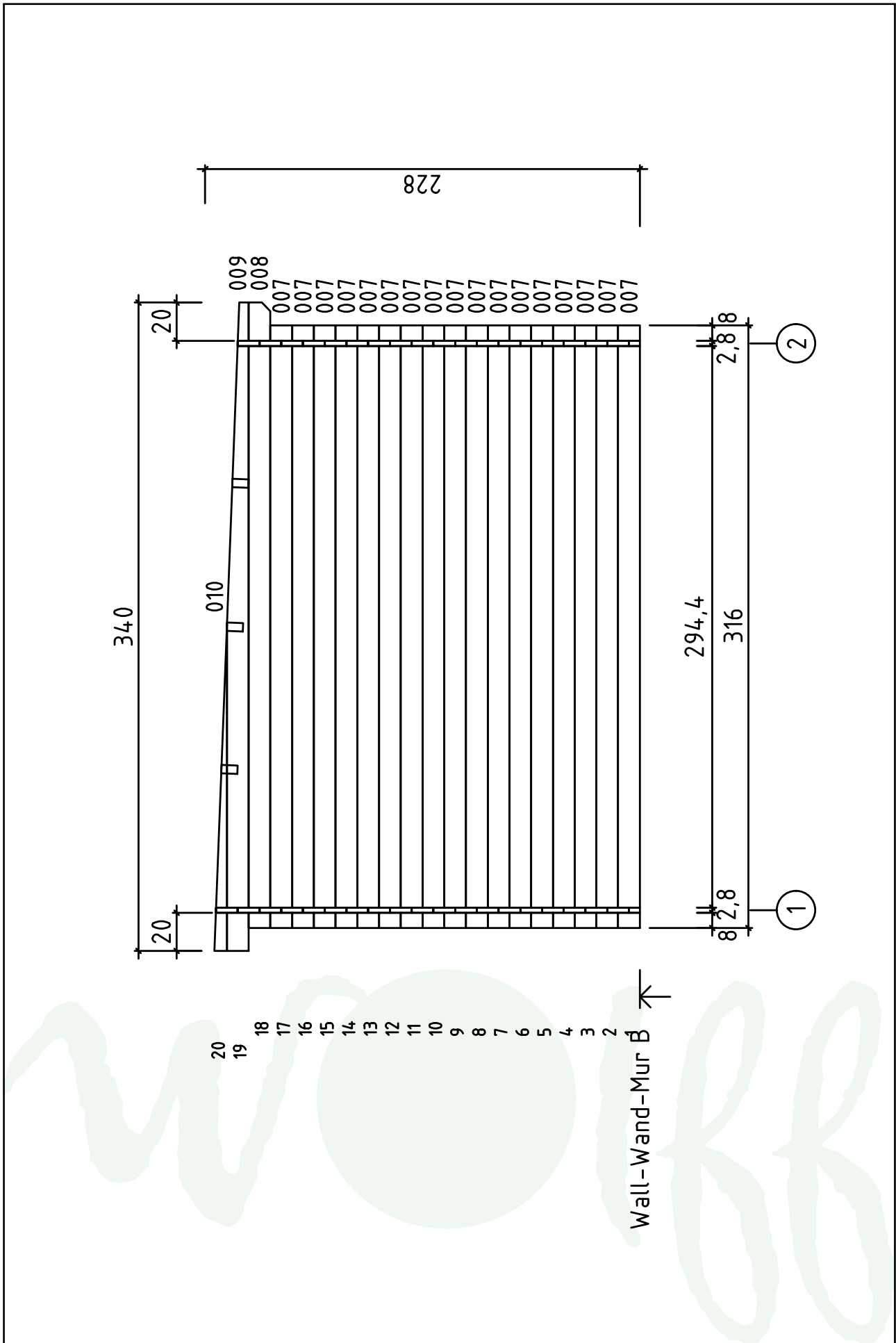

# Wandplan C Metz B

