

# Techn. Daten Bornholm 34-B

Wandaußenmaß: 300 x 300 cm

Bohlenstärke: 34 mm



Kontrolliert durch:

Achtung: Alle angegebenen Maße sind ca.-Maße!

# 3D-Darstellung Bornholm 34-B

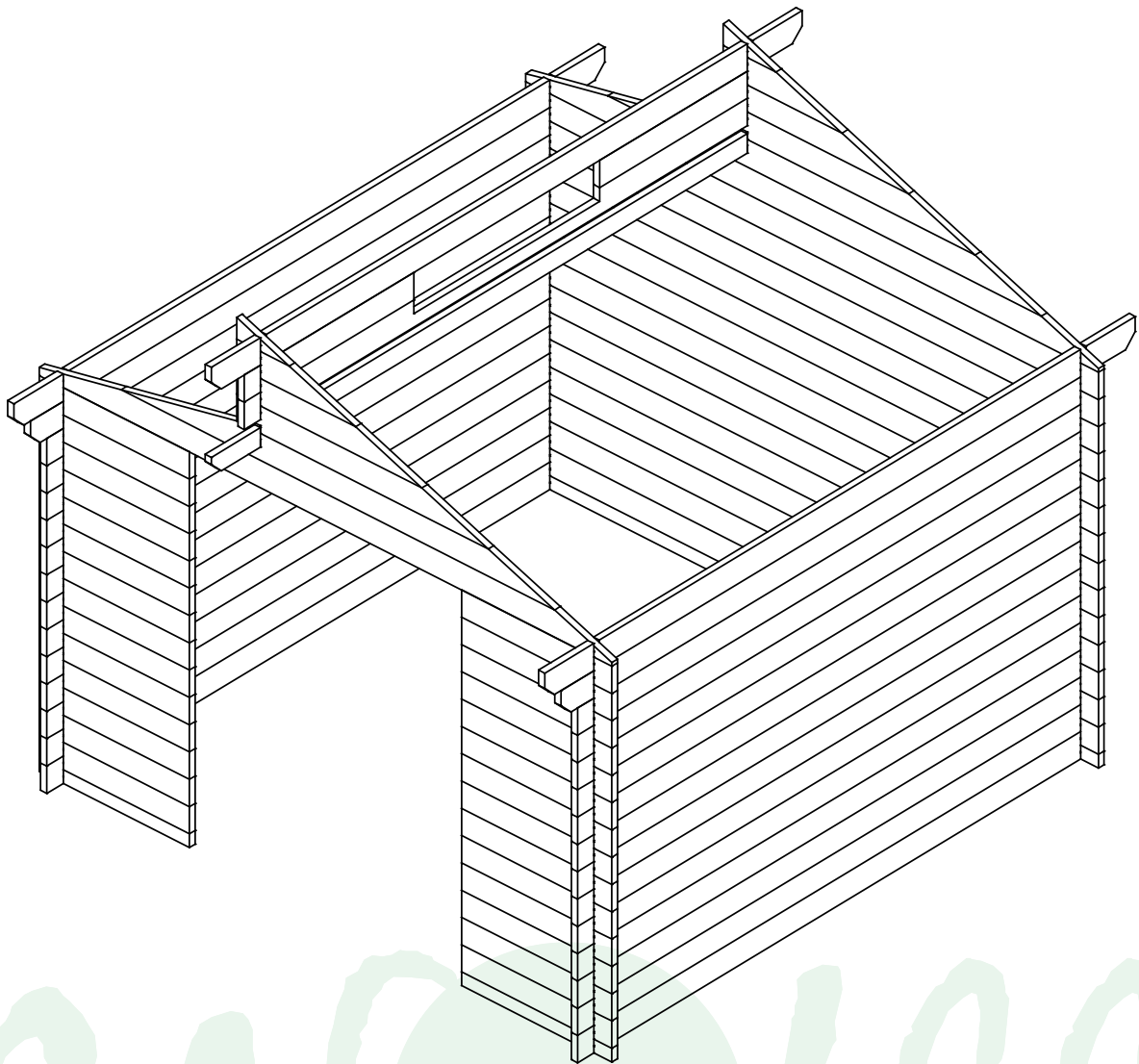

# Grundriss Bornholm 34-B

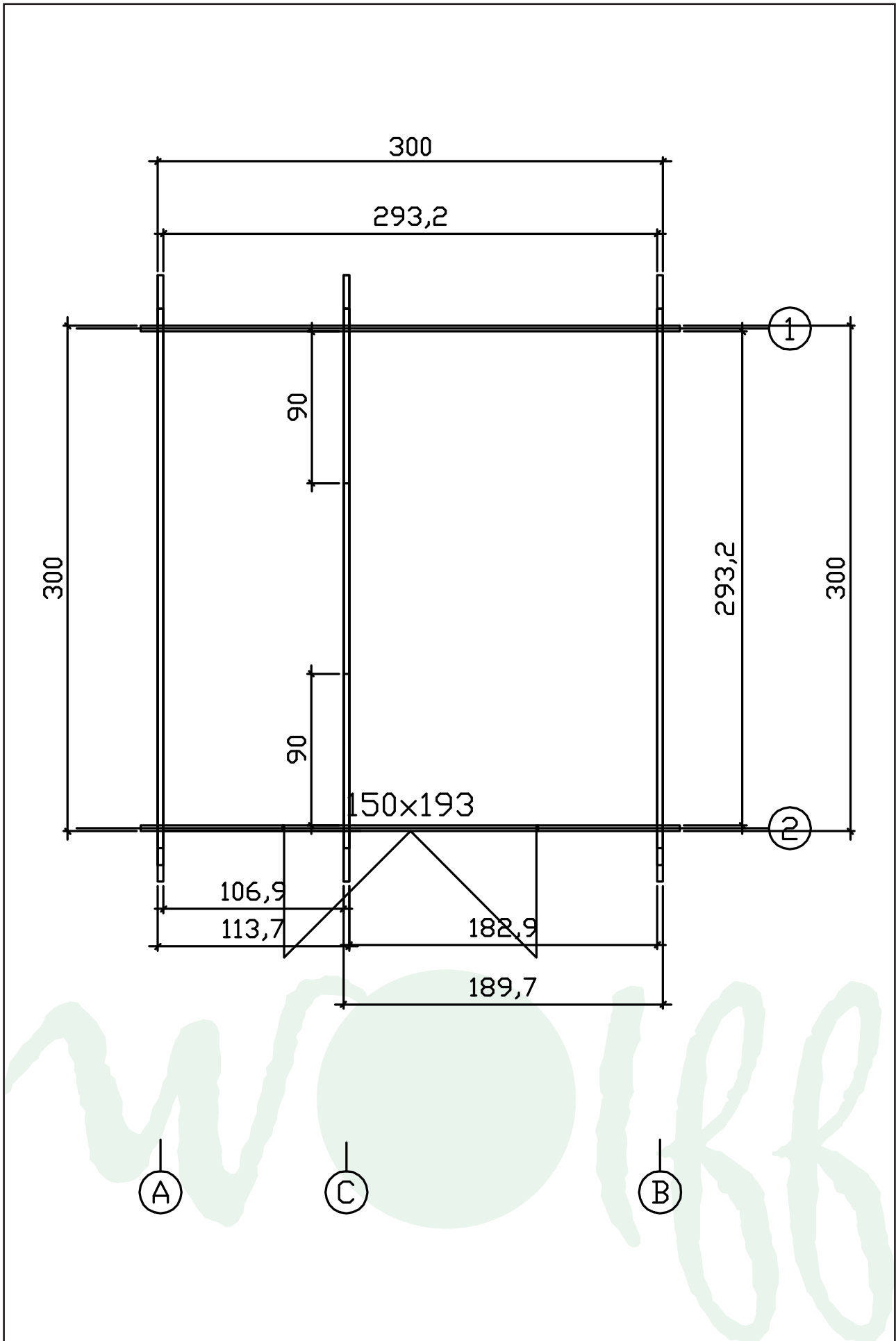

# Lagerholzplan Bornholm 34-B

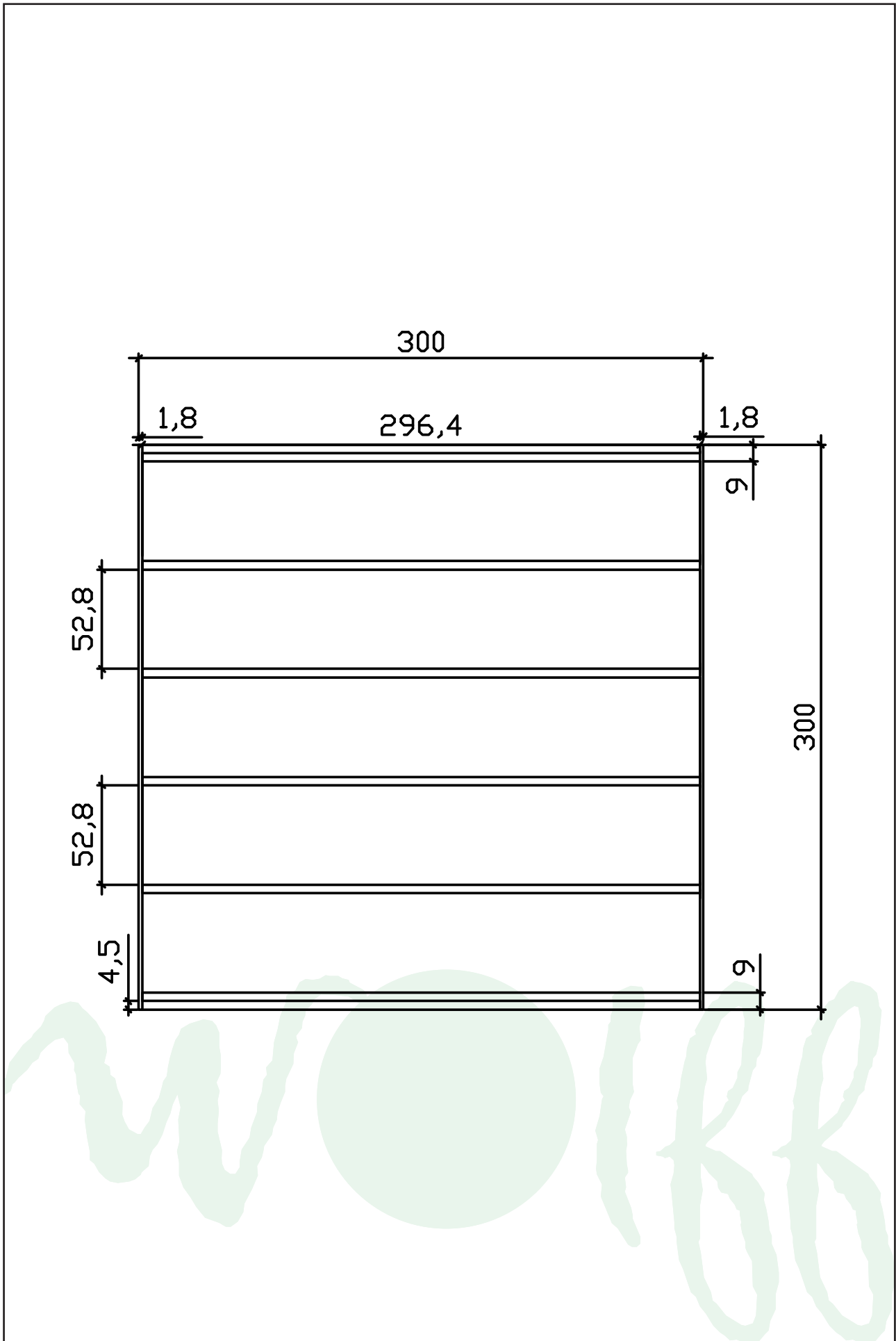

# Fundamentplan Bornholm 34-B



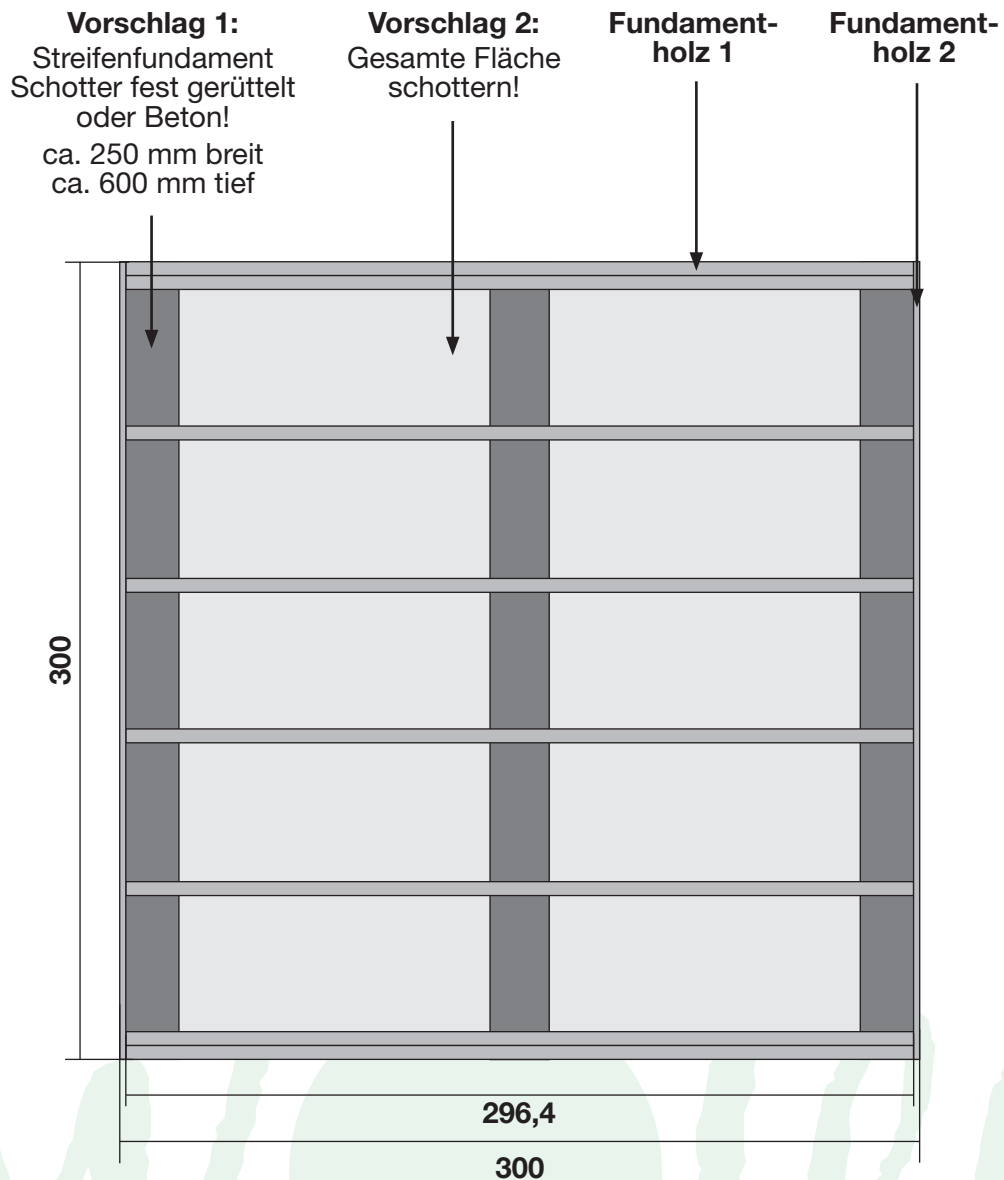





Typ	Anzahl der Fundamenthölzer (B x H x L)
Bornholm 34-B	Fundamentholz 1: 8 (43 x 90 x 296,4 mm) Fundamentholz 2: 2 (18 x 90 x 300 mm)

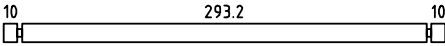
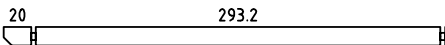
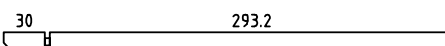
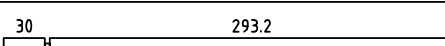
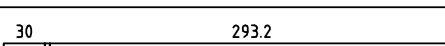
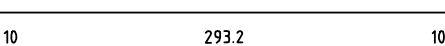
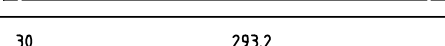
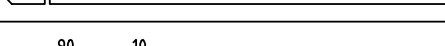
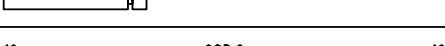
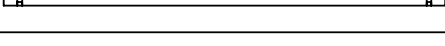

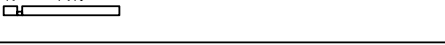
**Dieser Fundamentplan ist ein unverbindlicher Vorschlag und kann individuell verändert werden!**

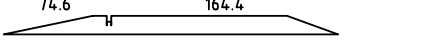
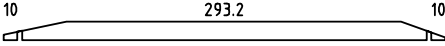









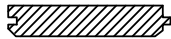



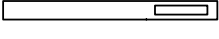



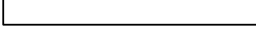
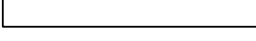

# Teileliste 1

## Bornholm 34-B

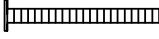
Pos		Stück	Profile (cm)	Länge (cm)
001		40	3.4x13.5	320
002		2	3.4x13.5	330
003		1	3.4x13.5	360
004		1	3.4x13.5	360
005		1	3.4x9.6	360
006		1	3.4x13.5	320
007		1	3.4x13.5	360
008		2	3.4x13.5	103.4
009		1	3.4x6.8	320
010		28	3.4x13.5	84
011		1	3.4x6.8	84
012		1	3.4x6.8	84
013		2	3.4x13.5	242.4
014		2	3.4x13.5	320
015		2	3.4x13.5	66.5
016		2	3.4x13.5	103.6
017		2	3.4x13.5	140.7
018		2	3.4x10.7	29.4
U5	DOOR 150x193	1		
U6	WINDOW 115x20 FIXED	1		
PT1	FOUNDATION/FUNDAMENT/SOLIVE	2	1.8x9.0	3000
AR1	FOUNDATION/FUNDAMENT/SOLIVE	8	4.3x9.0	2964
PR1	ROOF BEAM/DACHBALKEN/PANNE	1	4.3x14.5	3600
017	FLOOR BOARDS/FUSSBODEN/LAME DE PLANCHER	28	11.2x1.8	2910
018	ROOF BOARDS/DACHBRETTTER/VOLIGE	34	11.2x1.8	2510

# Teileliste 2

## Bornholm 34-B

Pos			Stück	Profile (cm)	Länge (cm)
019	ROOF BOARDS/DACHBRETTER/VOLIGE		6	11.2x1.8	1560
020	ROOF BOARDS/DACHBRETTER/VOLIGE		27	11.2x1.8	1427
021	ROOF EDGE REINFORCEMENT/TRAUFENLEISTE/TASSEAU		4	2.6x3.2	3600
022	ROOF EDGE REINFORCEMENT/TRAUFENLEISTE/TASSEAU		1	2.6x3.2	2930
023	PULLER/STURMLEISTEN/GARNITURE SLAT		4	2.6x3.2	2160
024	ROOF SIDE BOARDS/TRAUFENBRETT/PLANCHE DE RIVE		3	1.8x9	3600
025	ROOF SIDE BOARDS/TRAUFENBRETT/PLANCHE DE RIVE		2	1.8x9	300
026	PAPP BOARD/PAPPELIESTEN/CARTON RIVE 16		1	1.8x4	2930
027	FASCIA BOARD/GIEBELBLENDE/PLANCHE DE RIVE (FACADE)		2	1.8x14.0	1660
028	FASCIA BOARD/GIEBELBLENDE/PLANCHE DE RIVE (FACADE)		2	1.8x14.0	2610
029	FASCIA BOARD/GIEBELBLENDE/PLANCHE DE RIVE (FACADE)		4	1.8x9.0	1660
030	FASCIA BOARD/GIEBELBLENDE/PLANCHE DE RIVE (FACADE)		4	1.8x9.0	2610
031	FLOOR EDGE TRIM/FUßLEISTEN/PLINTHE PLANCHER		2	2.0x4.0	3000
032	FLOOR EDGE TRIM/FUßLEISTEN/PLINTHE PLANCHER		2	2.0x4.0	3000
033	DIAMOND/RAUTE/DIAMANT		2	1.8x12	120
034	BOLT/BOLZEN/BOULON		8	M8	80
035	Shim, Nut/Mutter, M8 mm - For fixing storm braces/Pour fixer les anti-tempete/Für Sturmleisten		8	M8	
036	Nails/Nägel/Clous 2.5 x 50 mm - For fixing roofboards Befestigung Dachbretter/P our fixer les voliges		400		
037	Nails/Nägel/Clous 4.0 40 mm - For fixing roofing felt fillet (18 x 90 mm)/ Befestigung Giebelabschlus Brett (18 x 90 mm)/ Pour fixer la latte de finition de la couverture (18 x 90 mm)		80		
038	Screws/Schrauben/Vis 4 x 60 mm - For fixing roof side boards and roof edge reinforcement/Befestigung Traufenbretter und Traufenleisten Pour fixer les planches de rive et le tasseau (30 x 34 mm) de renfort		280		
039	Nails/Nägel/Clous 1.4 x 40 mm - For fixing floor edge trims (19 x 19 mm)/ Befestigung Fußleisten/Pour fixer les plinthes du plancher (19 x 19 mm)		28		







# Wandplan C Bornholm 34-B

