

Caro 58-D

Wandaußenmaß: 480 x 480 cm
Bohlenstärke: 58 mm



Kontrolliert durch:

Achtung: Alle angegebenen Maße sind ca.-Maße!

3D-Ansicht Caro 58-D

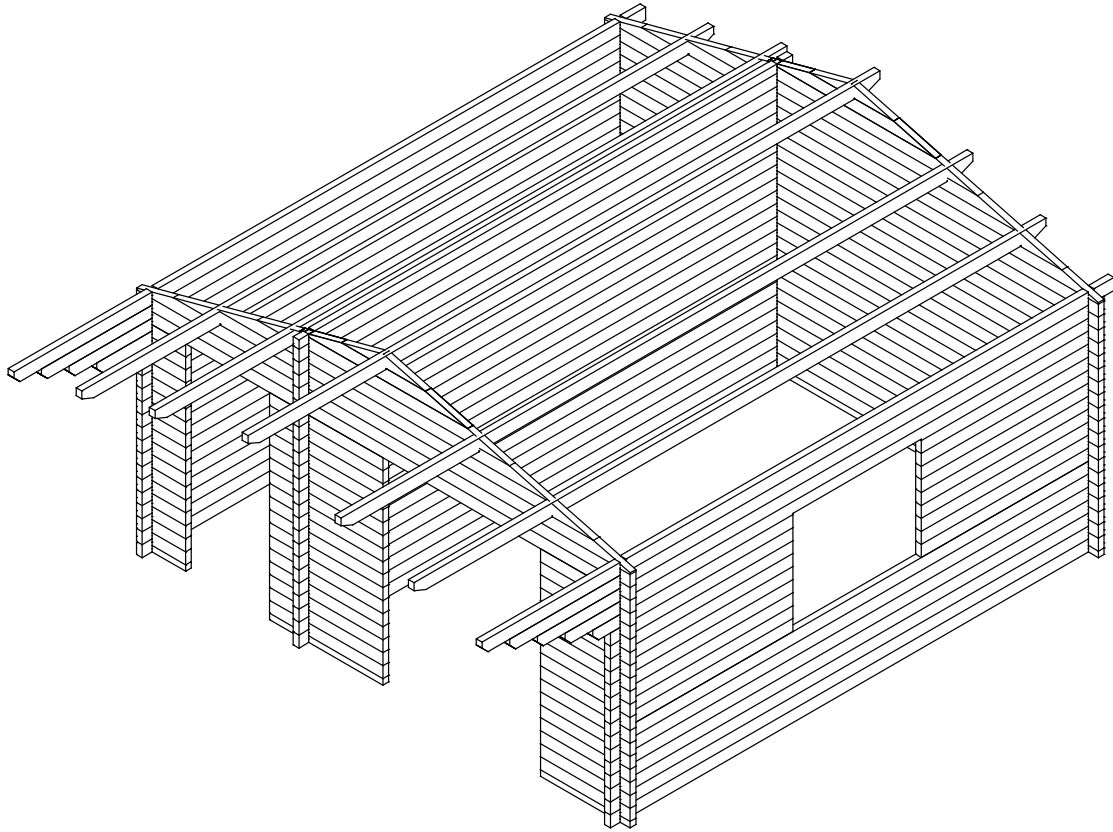

Grundriss Caro 58-D

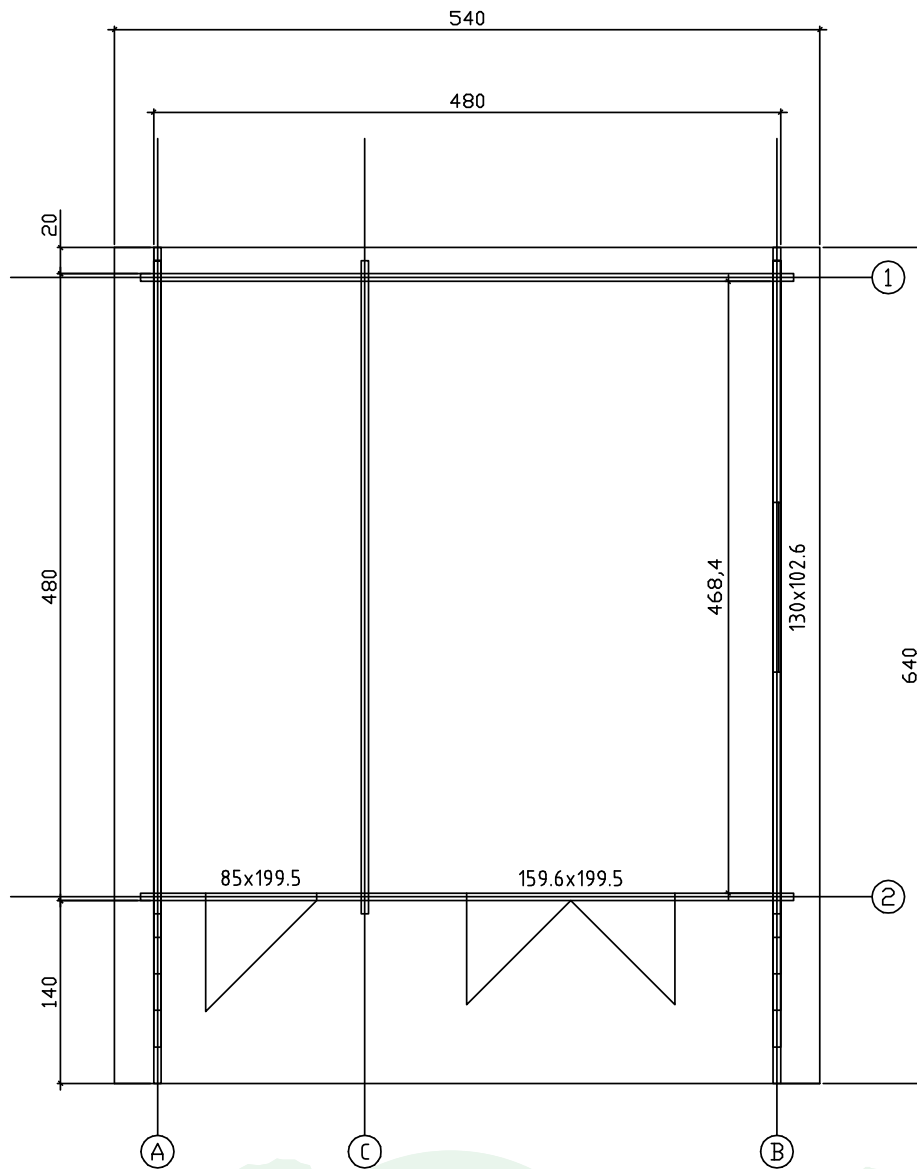

Lagerholzplan und Fundamentplan Caro 58-D

Wir empfehlen als Fundament für Ihr Gartenhaus eine vollflächig,
festgegründete gepflasterte oder betonierte Fläche.
Wahlweise ist auch ein Punkt- oder Streifenfundament möglich.

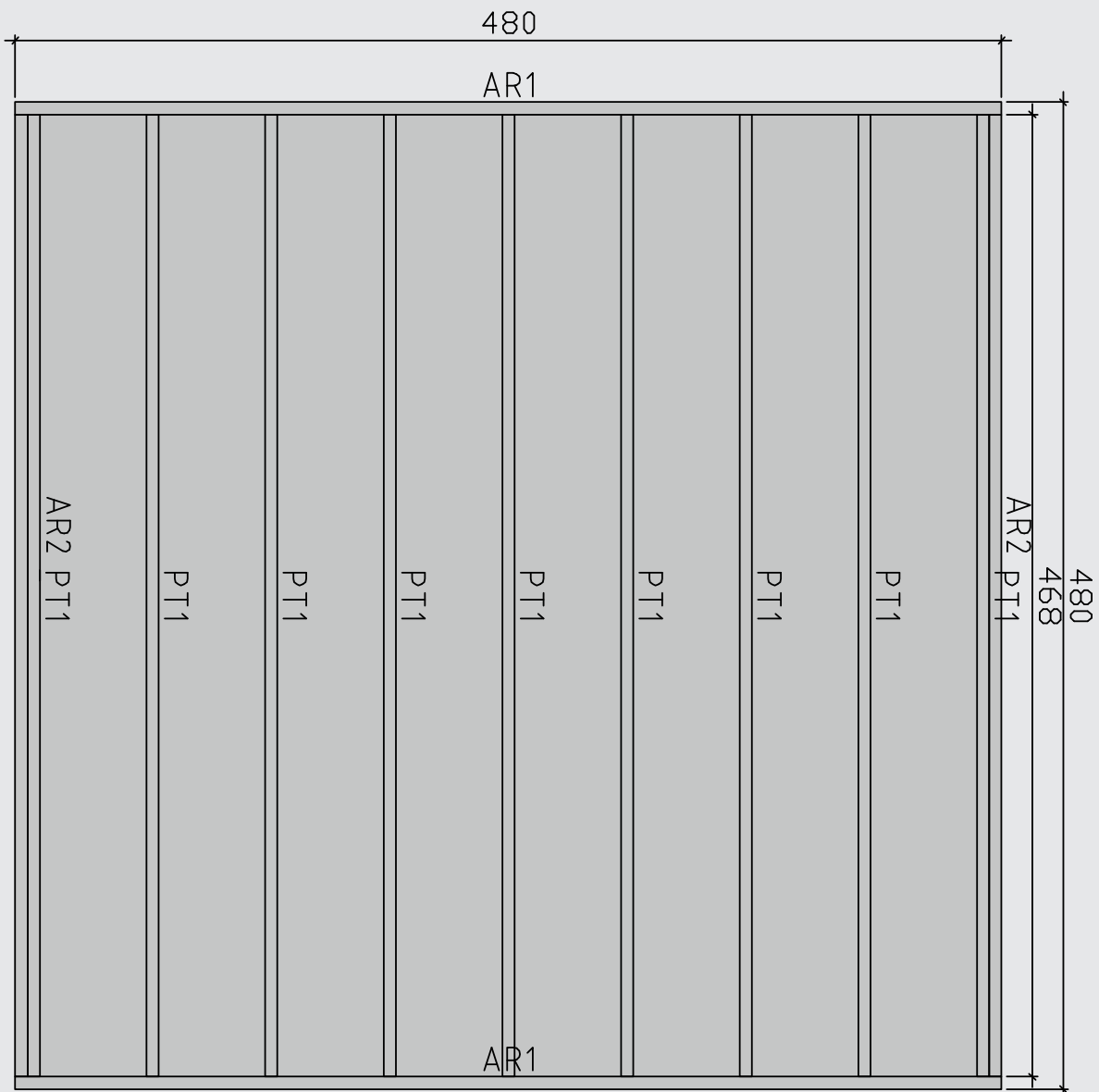









Teilleiste 1

Caro 58-D

Pos		Stück	Profile (cm)	Länge (cm)
001		1	5.8x5.7	500
002		21	5.8x11.4	500
003		2	5.8x11.4	500
004		2	5.8x11.4	425.8
005		2	5.8x11.4	340.7
006		2	5.8x11.4	255.5
007		2	5.8x11.4	170.3
008		2	5.8x11.4	85.2
009		1	5.8x5.7	49.8
010		1	5.8x5.7	114.8
011		1	5.8x5.7	90.8
012		17	5.8x11.4	49.8
013		17	5.8x11.4	114.8
014		17	5.8x11.4	90.8
015		45	5.8x11.4	500
016		1	5.8x11.4	518
017		1	5.8x11.4	546
018		2	5.8x11.4	574
019		2	5.8x11.4	602
020		1	5.8x11.4	640
021		17	5.8x11.4	185
022		1	5.8x11.4	203
023		1	5.8x11.4	546
024		1	5.8x11.4	640
025		1	5.8x8.3	500

Teileliste 2







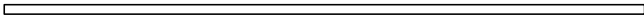
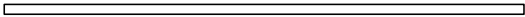
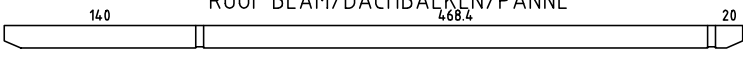
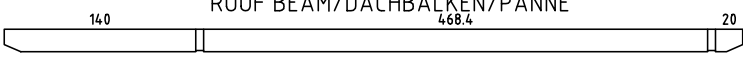
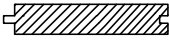
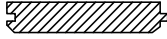

Caro 58-D

Pos		Stück	Profile (cm)	Länge (cm)
038	Nails/Nägels/Clous 2.5 x 50 mm - For fixing roofboards Befestigung Dachbretter/P our fixer les voliges		680	
039	Nails/Nägels/Clous 2.0 40 mm - For fixing roofing felt fillet (18 x 90 mm)/ Befestigung Giebelabschlu ßbrett (18 x 90 mm)/ Pour fixer la latte de finition de la couverture (18 x 90 mm)		48	
040	Screws/Schrauben/Vis 4 x 50 mm - For fixing roof side boards and roof edge reinforcement/Befestigung Traufenbretter und Traufenleisten Pour fixer les planches de rive et le tasseau (30 x 34 mm) de renfort		120	
041	Screws/Schrauben/Vis 2.5X25 mm - For fixing window and door trims/ Befestigung Fenster und Türen/P our fixer les croisillons des fenetres et des portes		100	
042	Screws/Schrauben/Vis 4 x 50 mm - For fixing first row of wall logs/ Fixierung des ersten Bohlenkranzes/Pour fixer le premier rang de madrier		9	
043	Nails/Nägels/Clous 2.5 x 50 mm - For fixing floorboards/ Befestigung Fu ßbodenbretter/Pour fixer les lames de plancher		360	
044	Nails/Nägels/Clous 1.4 x 40 mm - For fixing floor edge trims (19 x 19 mm)/ Befestigung Fu ßleisten/Pour fixer les plinthes du plancher (19 x 19 mm)		52	
045	Screws/Schrauben/Vis 4x70 mm - For bearers/ Befestigung Fundamentbalken/Pour fixer les solives		26	

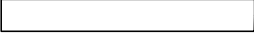
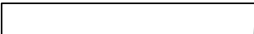

Teileliste 3

Caro 58-D

Pos		Stück	Profile (cm)	Länge (cm)
PT1	FOUNDATION/FUNDAMENT/SOLIVE 	9	6x7	468
AR2	FOUNDATION/FUNDAMENT/SOLIVE 	2	6x7	480
AR1	FOUNDATION/FUNDAMENT/SOLIVE 	2	6x7	468
PR1	ROOF BEAM/DACHBALKEN/PANNE 	4	5.8x12.0	640
PR2	ROOF BEAM/DACHBALKEN/PANNE 	1	5.8x12.0	640
A2	WINDOW 130x102.6	1		
	DOOR 159.6x199.5	1		
	DOOR 85x199.5	1		
026	FLOOR BOARDS/FUSSBODEN/LAME DE PLANCHER 	42	11.2x2.7	4680
027	ROOF BOARDS/DACHBRETTER/VOLIGE 	116	11.2x1.8	2795
028	ROOF EDGE REINFORCEMENT/TRAUFENLEISTE/TASSEAU 	2	2.6x3.2	6400
029	ROOF SIDE BOARDS/TRAUFENBRETT/PLANCHE DE RIVE 	2	1.8x9	6400
030	FASCIA BOARD/GIEBELBLENDE/PLANCHE DE RIVE (FACADE) 	4	1.8x12.0	2740
031	FASCIA BOARD/GIEBELBLENDE/PLANCHE DE RIVE (FACADE) 	4	1.8x7.0	2740
032	ROOFING FELT FILLET/GIEBELABSCHLUSSBRETT/LATTE DE FINITION COUVERTURE 	4	1.8x7.0	2740
033	FLOOR EDGE TRIM/FUßLEISTEN/PLINTHE PLANCHER 	6	2.0x4.5	4684
034	DIAMOND/RAUTE/DIAMANT 	2	1.8x12	
035	METAL STORM BRACE/GEWINDESTANGE/TIGE FILETEE 	5	M10	200
036	Shim, Nut/Mutter, U-Scheibe/Ecrou,Rondelle - M10 mm - For fixing storm braces/Pour fixer les anti-tempete/Für Sturmleisten 	8	M10	
037	CONNECTION NUT/ÜBERWURFMUTTER/ECROU DE RACCORDEMENT 	4	M10	

Wandplan 1 und 2

Caro 58-D

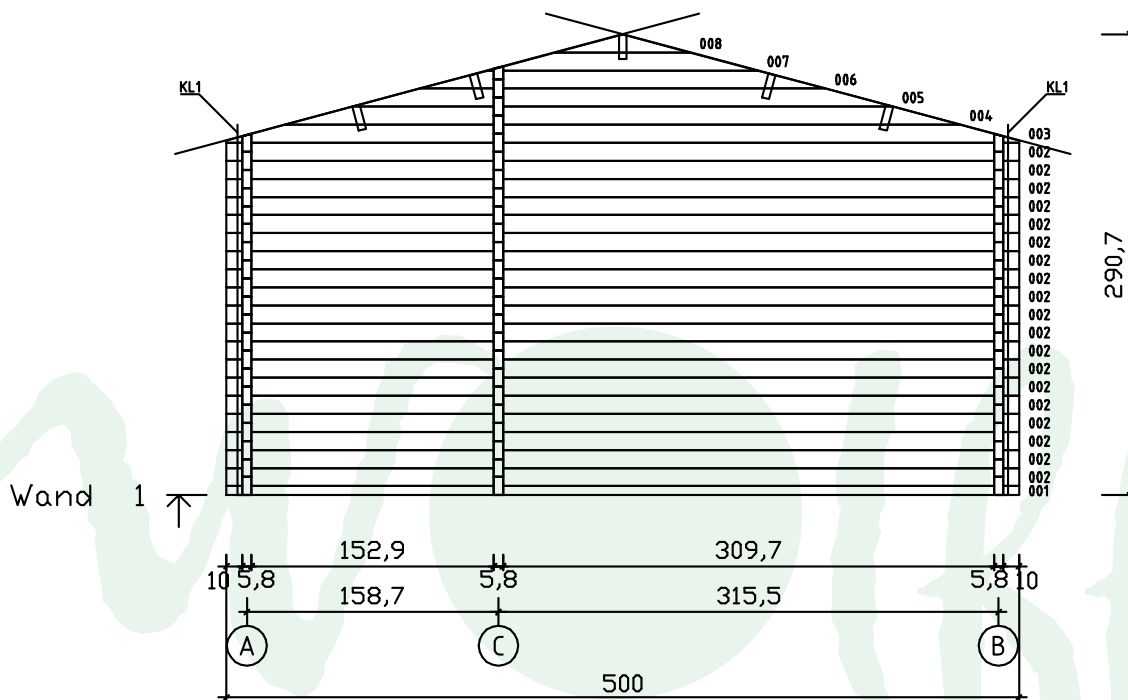
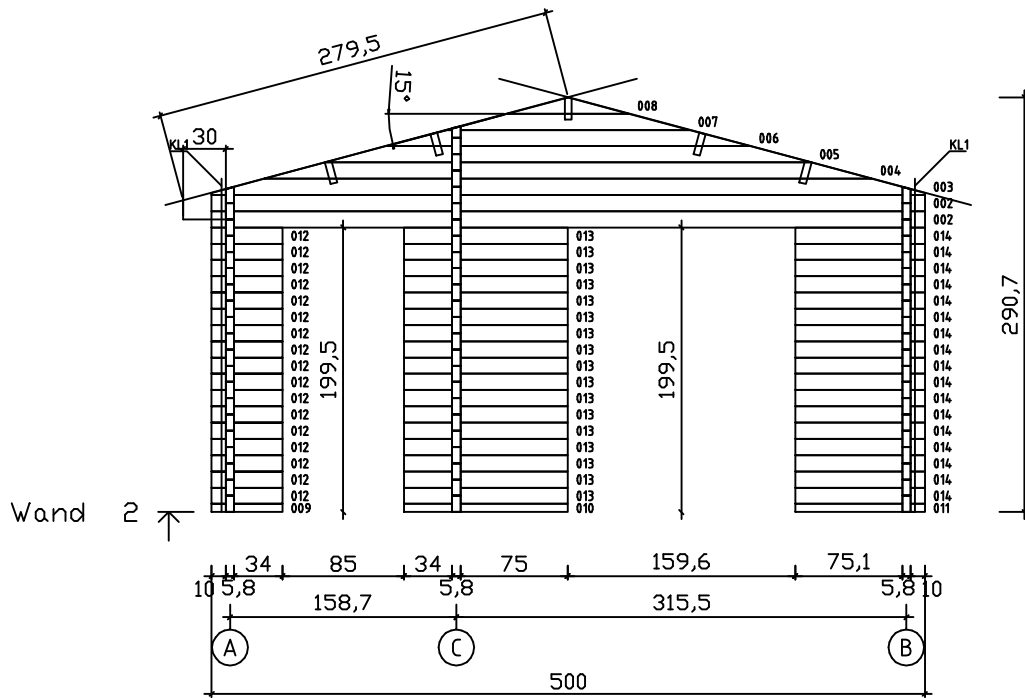

Wandplan A und B Caro 58-D

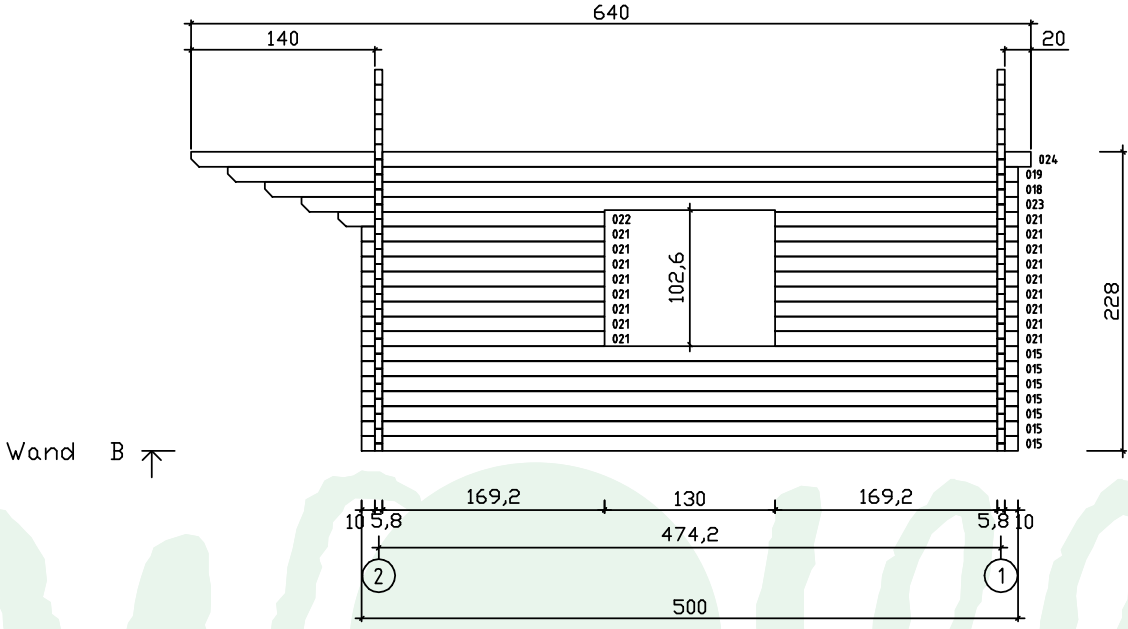
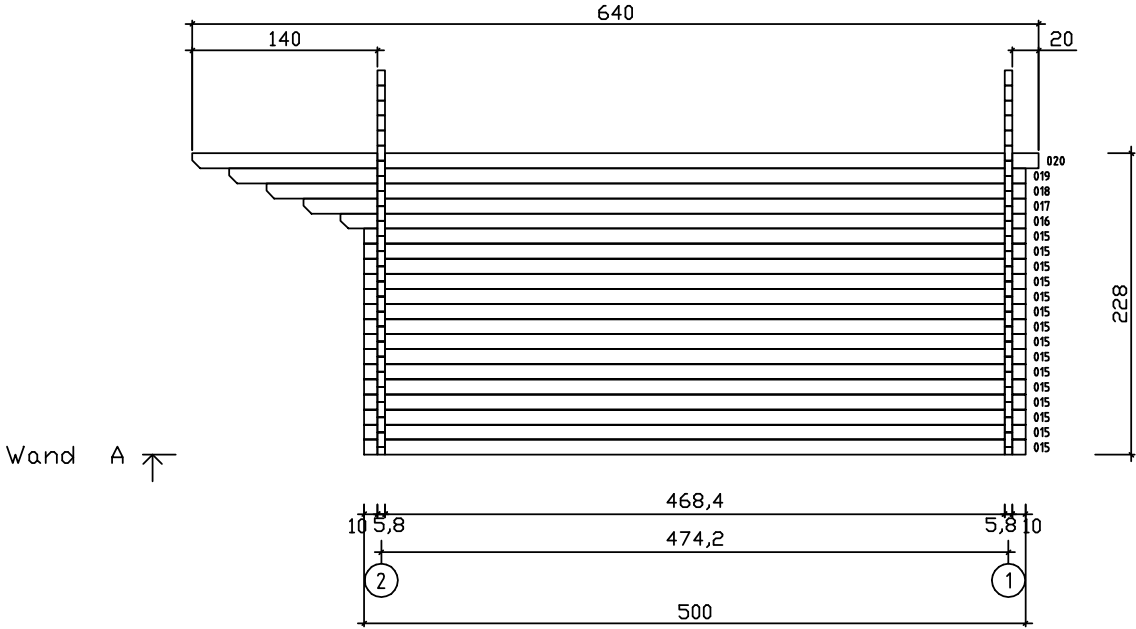

Wandplan C

Caro 58-D

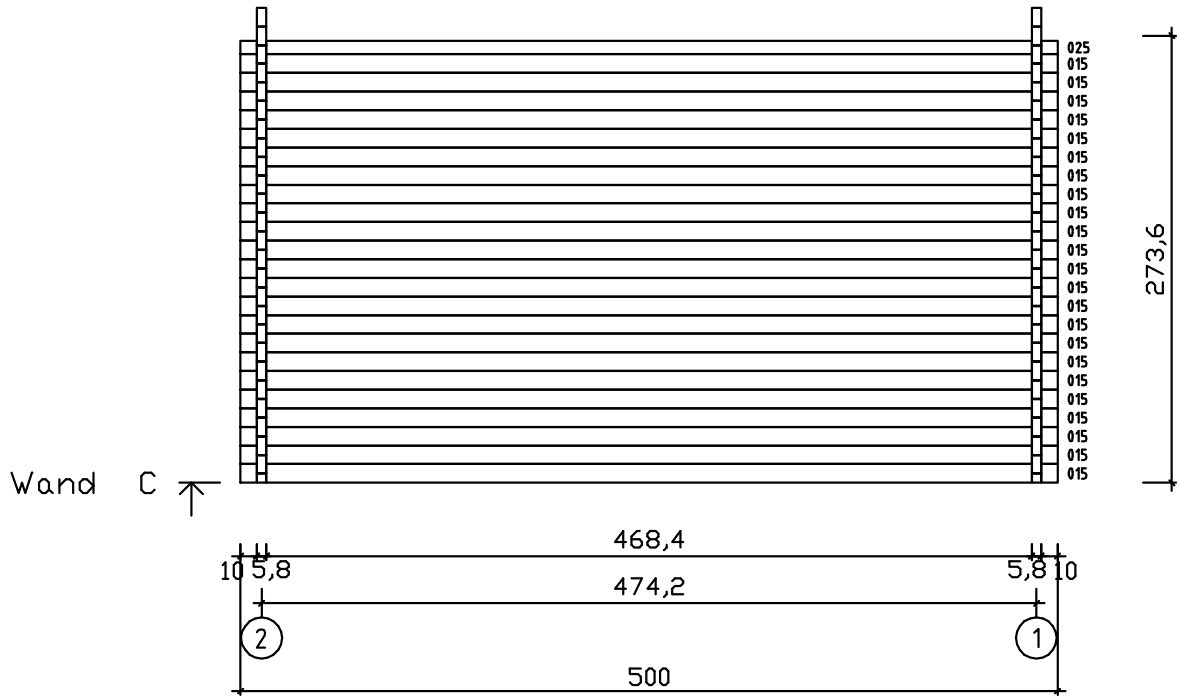

woi 188