

Technische Daten Caro 34

Wandaußenmaß: 450 x 300 cm

Bohlenstärke: 34 mm



Kontrolliert durch:

Achtung: Alle angegebenen Maße sind ca.-Maße!

3D-Darstellung Caro 34

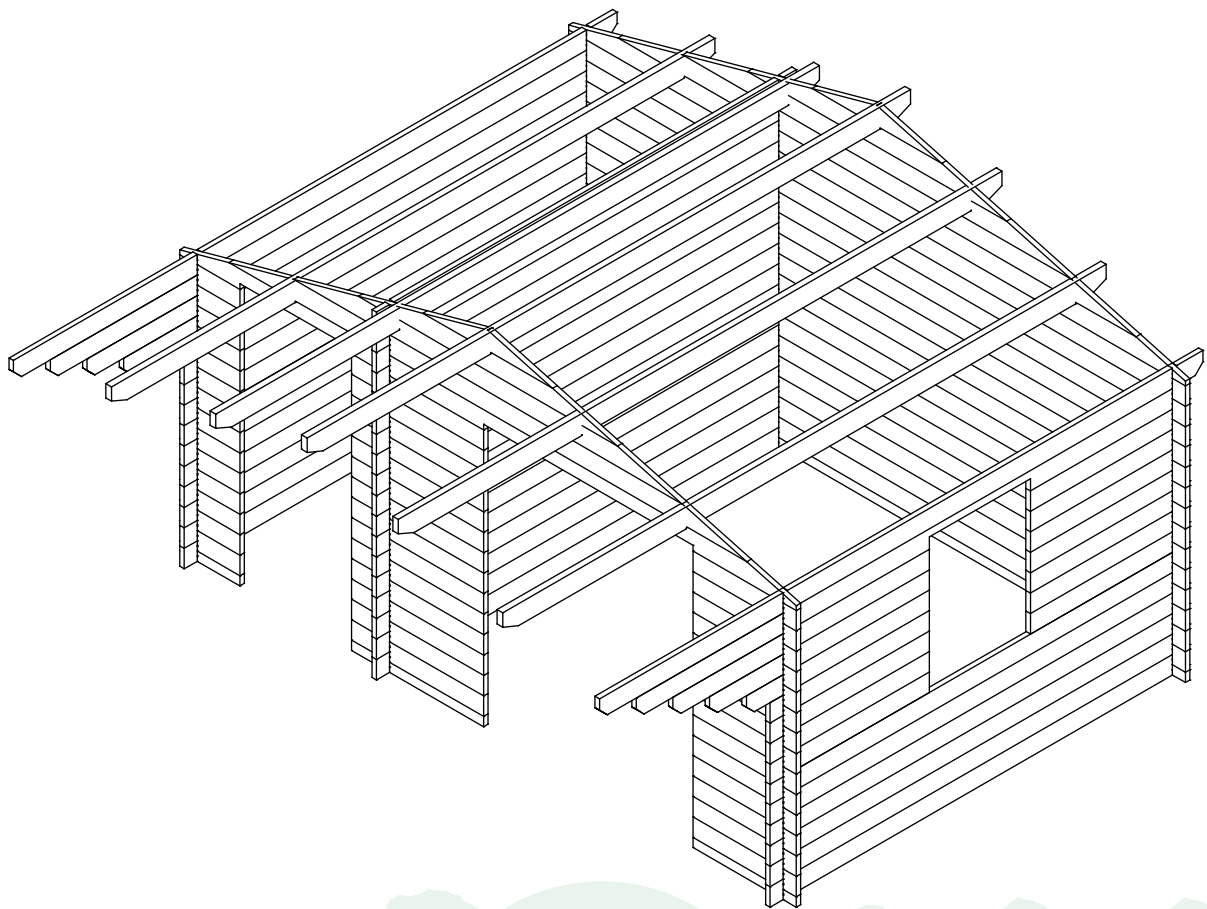

Grundriss und Lagerholzplan Caro 34

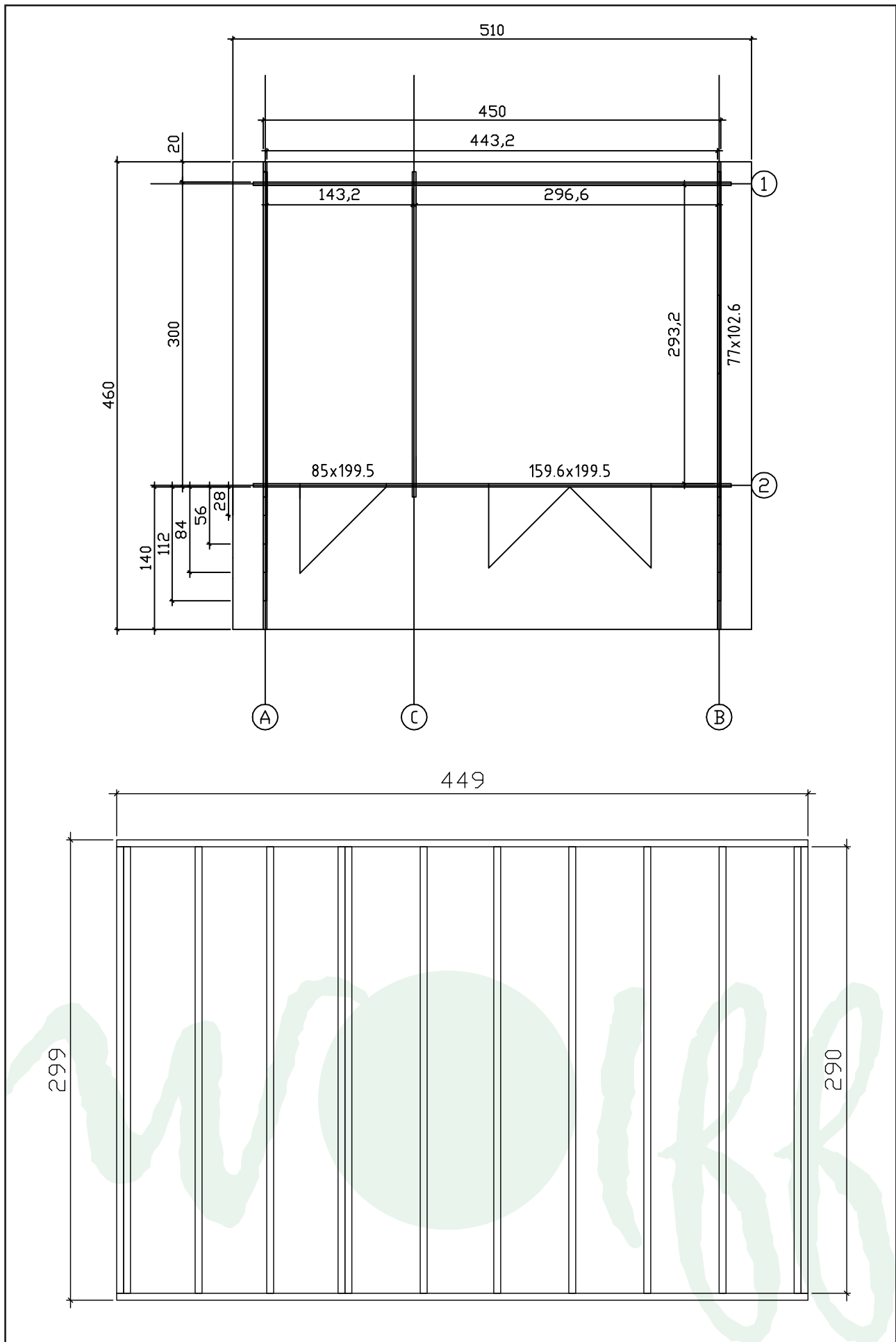

Fundamentplan Caro 34

Haustyp	Anzahl der Fundamenthölzer (B x H x L)
Caro 34	Fundamentholz 1: 2 (45 x 70 x 4490 mm) Fundamentholz 2: 2 (45 x 70 x 2900 mm) Fundamentholz 2: 11 (45 x 70 x 2900 mm)

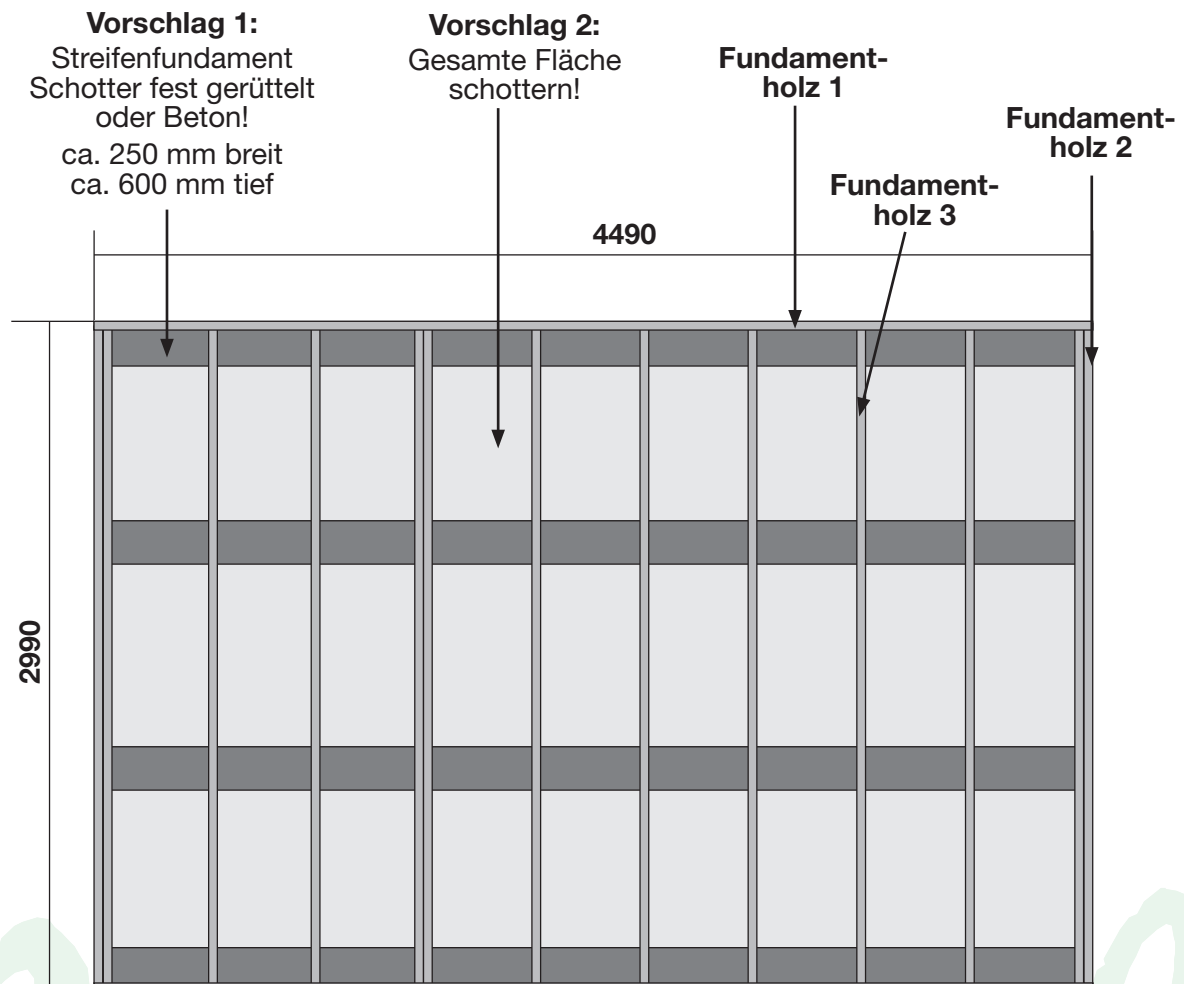

Dieser Fundamentplan ist ein unverbindlicher Vorschlag und kann individuell verändert werden!









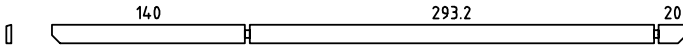
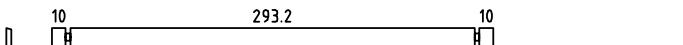
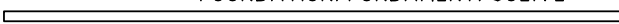
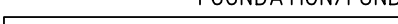
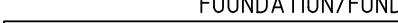
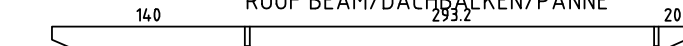
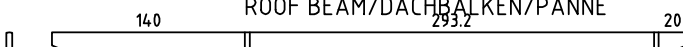

Teileliste 1

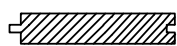
Caro 34

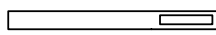
Pos		Stück	Profile (cm)	Länge (cm)
001		1	3.4x6.8	470
002		14	3.4x13.5	470
003		1	3.4x13.5	470
004		2	3.4x13.5	394
005		2	3.4x13.5	295.5
006		2	3.4x13.5	197
007		2	3.4x13.5	98.5
008		1	3.4x6.8	46
009		1	3.4x6.8	100.7
010		1	3.4x6.8	78.7
011		14	3.4x13.5	46
012		14	3.4x13.5	100.7
013		14	3.4x13.5	78.7
014		1	3.4x13.5	470
015		33	3.4x13.5	320
016		1	3.4x13.5	338
017		1	3.4x13.5	366
018		1	3.4x13.5	394
019		1	3.4x13.5	422
020		1	3.4x13.5	460
021		11	3.4x13.5	121.5
022		1	3.4x13.5	139.5
023		1	3.4x13.5	167.5
024		1	3.4x13.5	195.5
025		1	3.4x13.5	422

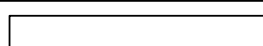
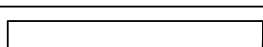
Teileliste 2

Caro 34

Pos		Stück	Profile (cm)	Länge (cm)
026		1	3.4x13.5	460
027		1	3.4x13.2	320
AR2	FOUNDATION/FUNDAMENT/SOLIVE 	2	4.5x7	449
AR1	FOUNDATION/FUNDAMENT/SOLIVE 	2	4.5x7	290
PT1	FOUNDATION/FUNDAMENT/SOLIVE 	11	4.5x7	290
PR1	ROOF BEAM/DACHBALKEN/PANNE 	4	4.3x14.5	460
PR2	ROOF BEAM/DACHBALKEN/PANNE 	1	4.3x14.5	460
	WINDOW 77x102.6	1		
	DOOR 159.6x199.5	1		
	DOOR 85x199.5	1		
028	FLOOR BOARDS/FUSSBODEN/LAME DE PLANCHER 	27	11.2x1.8	295.8
029	FLOOR BOARDS/FUSSBODEN/LAME DE PLANCHER 	27	11.2x1.8	142.4
030	ROOF BOARDS/DACHBRETTER/VOLIGE 	82	11.2x1.8	251.5
031	ROOF EDGE REINFORCEMENT/TRAUFENLEISTE/TASSEAU 	2	2.6x3.2	460.0
032	PULLER/STURMLEISTEN/GARNITURE SLAT 	4	2.6x3.2	200.0
033	ROOF SIDE BOARDS/TRAUFENBRETT/PLANCHE DE RIVE 	2	1.8x9	460.0
034	FASCIA BOARD/GIEBELBLENDE/PLANCHE DE RIVE (FACADE) 	4	1.8x12.0	257.1
035	FASCIA BOARD/GIEBELBLENDE/PLANCHE DE RIVE (FACADE) 	4	1.8x6.0	257.1
036	FLOOR EDGE TRIM/FUßLEISTEN/PLINTHE PLANCHER 	2	2.0x4.5	443.0
037	FLOOR EDGE TRIM/FUßLEISTEN/PLINTHE PLANCHER 	2	2.0x4.5	443.0
038	DIAMOND/RAUTE/DIAMANT 	2	1.8x12	120

Wandpläne 3

Caro 34

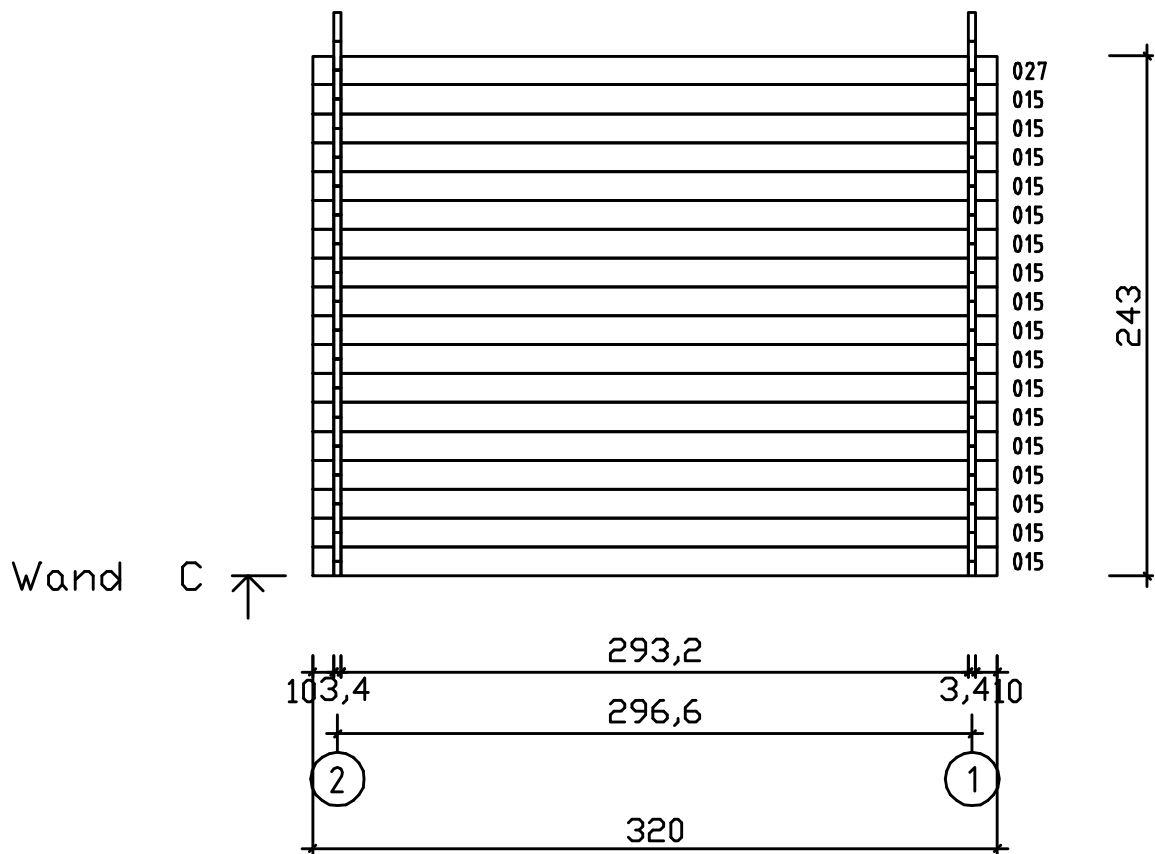

Detail Caro 34

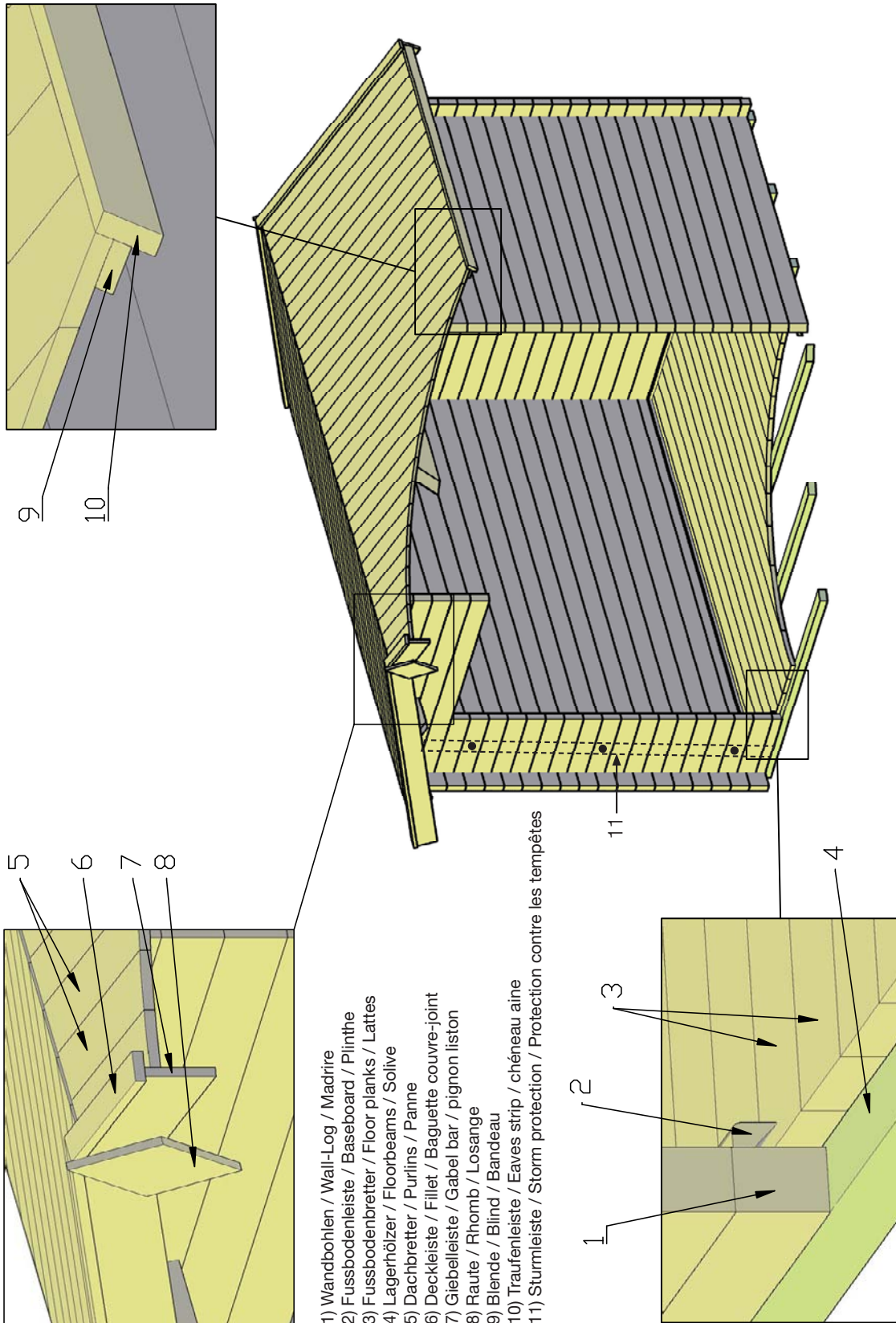

- 1) Wandbohlen / Wall-Log / Madrire
- 2) Fussbodenleiste / Baseboard / Plinthe
- 3) Fussbodenbretter / Floor planks / Lattes
- 4) Lagerhölzer / Floorbeams / Solive
- 5) Dachbretter / Purlins / Panne
- 6) Deckleiste / Fillet / Baguette couvre-joint
- 7) Giebeleiste / Gabel bar / pignon liston
- 8) Raute / Rhomb / Losange
- 9) Blende / Blind / Bandeau
- 10) Traufenleiste / Eaves strip / chéneau aine
- 11) Sturmleiste / Storm protection / Protection contre les tempêtes